

IT - RICEVITORE 230Vac CON FUNZIONE DIMMER PER IL CONTROLLO DI CARICHI DI TIPO RESISTIVO, CAPACITIVO, INDUTTIVO E LED. Ingresso pulsante manuale.

EN - 230Vac RECEIVER WITH DIMMER FUNCTION FOR THE CONTROL OF RESISTIVE, CAPACITIVE, INDUCTIVE AND LED LOADS. Push-button input for manual controls.

FR - RÉCEPTEUR SANS FIL 230Vac AVEC FONCTION VARIATION POUR LE CONTROLE DE CHARGES DE TYPE RESISTIF, CAPACITIF, INDUCTIF ET LED. Entrée pour bouton-poussoir.

DE - 230Vac DRAHTLOSER EMPFÄNGER MIT DIMM-FUNKTION FÜR DIE STEUERUNG VON LEDS, INDUKTIVEN, KAPAZITIVEN UND WIDERSTANDSLASTEN. Eingang manueller Taster.

IT - Codice prodotto
 EN - Product code
 FR - Code du produit
 DE - Artikelnummer

TVDLC868A01 (868.3Mhz) **TVDLC916A01** (916Mhz)
TVDLC000A01 (senza ricevitore radio integrato, without built-in radio receiver, sans récepteur intégré, ohne integrierem Funkempfänger)

IT - Tasto di programmazione P2
 EN - Programming button P2
 FR - Bouton de programmation P2
 DE - Programmierungstaste P2

IT - Antenna
 EN - Aerial
 FR - Antenne
 DE - Antenne

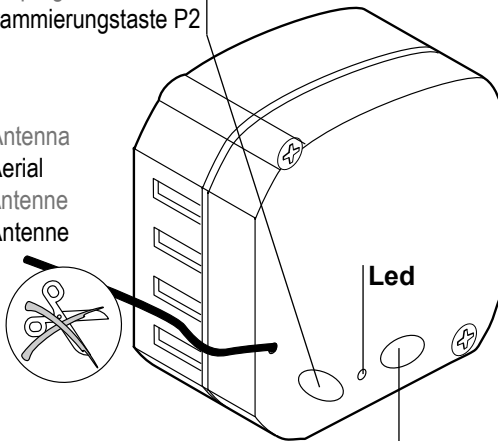

IT - Tasto di programmazione P1 (ricevitore radio)
 EN - Programming button P1 (radio receiver)
 FR - Bouton de programmation P1 (récepteur radio)
 DE - Programmierungstaste P1 (Funkempfänger)

Carico - Load - Charge - Last	Min.	Max.
<i>Resistivo - Resistive Resistif - Widerstandlast</i>	25W	250W
<i>Induttivo - Inductive Inductif - Induktiv</i>	25VA	250VA
<i>Capacitivo - Capacitive Capacitif - Kapazitiv</i>	25VA	250VA
LED	7W	100W

IT - Dimensioni
 EN - Dimensions
 FR - Dimensions
 DE - Abmessungen

Montaggio
 Mounting
 Fixation
 Montage

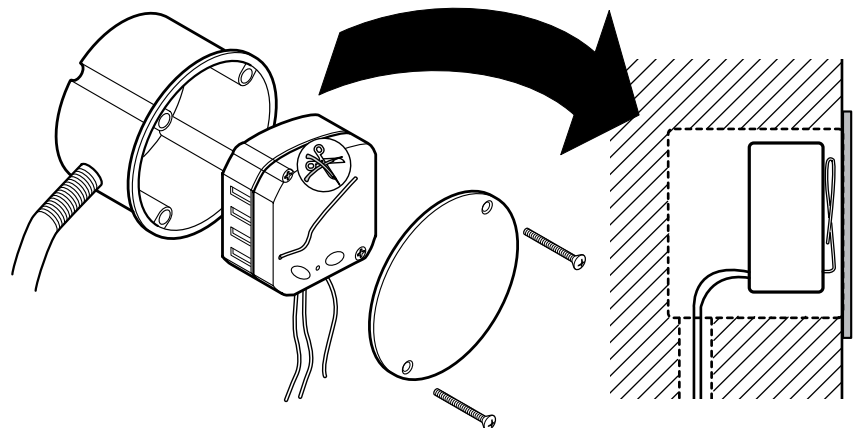
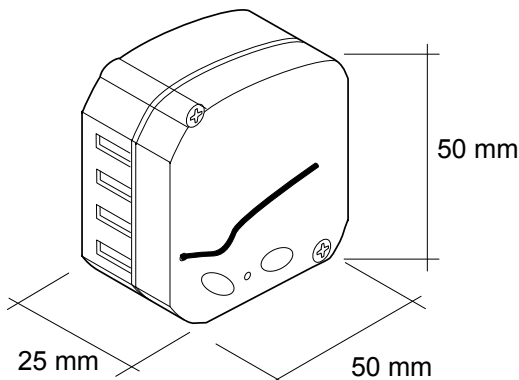

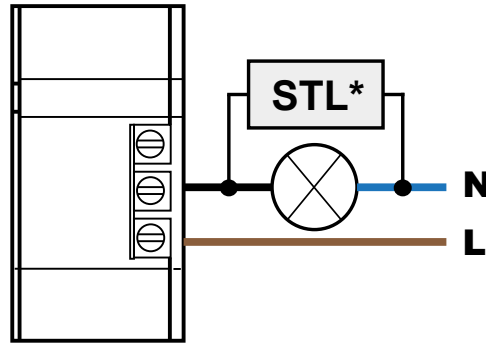
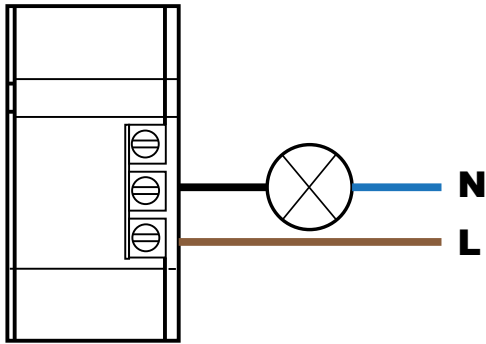

IT - Ingresso pulsante
FR - Entrée pour bouton-poussoir

EN - Push-button input
DE - Eingang Taster

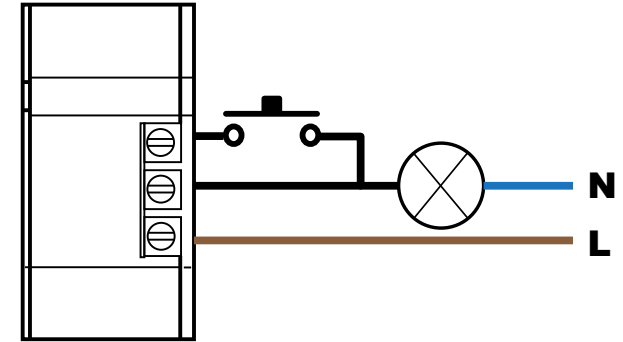

oppure or ou oder

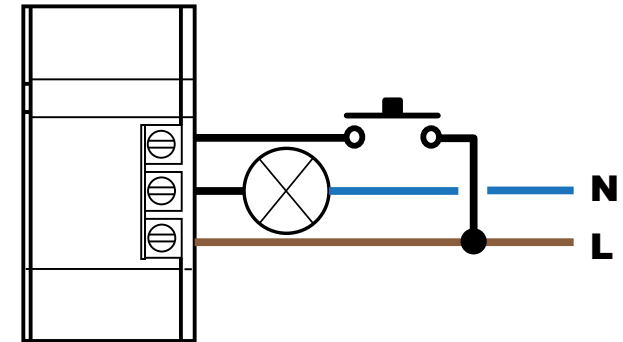

*
IT - Circuito stabilizzatore (in dotazione)
EN - Snubber circuit (included).
FR - Circuit stabilisateur (inclus).
DE - Stabilisierender Schaltkreis (inbegriffen).

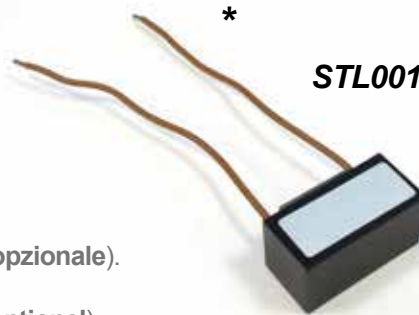

*
IT - Circuito stabilizzatore per carichi LED minimi (opzionale).
EN - Snubber circuit for low LED loads (optional).
FR - Circuit stabilisateur pour LED à faible charge (optionnel).
DE - Stabilisierender Schaltkreis für minimale LED Lasten (optional).

IT - È possibile collegare in parallelo più di un pulsante.
EN - It's possible to connect in parallel more than one push-button.
FR - Il est possible de brancher en parallèle plus d'un bouton-poussoir.
DE - Es ist möglich mehr als einen Taster parallel zu schalten.



1.1

IT - Configurazione del tipo di carico **EN - Configuration of the load type**
FR - Configuration du type de charge **DE - Konfigurierung der Lastart**

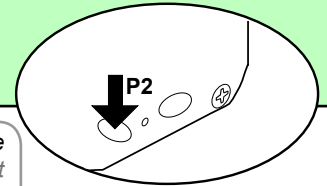

IT - È possibile ripetere la procedura al fine di identificare le migliori impostazioni del sistema, specialmente in caso di carichi LED. EN - It's possible to repeat the procedure in order to identify the most suitable setting of the system, especially in case of LED loads. FR - Il est possible de répéter la procédure afin de vérifier quelle sera la meilleure programmation du système, notamment en cas de charges LED. DE - Es ist möglich die Prozedur zu wiederholen um die geeigneten Systemeinstellungen zu identifizieren, insbesondere im Falle von LED Lasten.

*** tenere premuto**
keep it pressed
maintenir appuyé
gedrückt halten

VALORE CONFIGURATO
CONFIGURED VALUE
VALEUR CONFIGURÉE
KONFIGURIERTER WERT

NUOVO VALORE
NEW VALUE
NOUVELLE VALEUR
NEUER WERT

suono intermittente
intermittent sound
son intermittente
intermittierender Ton

5 s

IT - Premere **2 volte** il tasto **P2** e tenere premuto.
EN - Press **2 times** the button **P2** and keep it pressed.
FR - Appuyer **2 fois** sur le bouton **P2** et le maintenir appuyé.
DE - 2 mal die Taste **P2** drücken und gedrückt halten.

IT - Premere **P2** per passare alle configurazioni successive (vedi sotto).
EN - Press **P2** to switch to the next configurations (see below).
FR - Appuyer sur **P2** pour passer aux paramètres suivants (voir ci-dessous).
DE - Drücken Sie **P2** um zur darauffolgenden Konfigurierung zu wechseln (siehe unten).

IT - Attendere **5s.** per memorizzare.
EN - Wait **5s.** to memorize.
FR - Attendre **5s** pour mémoriser
DE - Warten Sie **5 Sek.** um einzulernen.

P2	🔊 / ☀️	Carico - Load - Charge - Last
		TRASFORMATORI ELETTRONICI (carico capacitivo) - ELECTRONIC TRANSFORMERS (capacitive load) TRANSFORMATEURS ÉLECTRONIQUE (charge capacitive) - ELEKTRONISCHER TRANSFORMATOREN (Kapazitive Last) LAMPADE A LOGENE / A INCANDESCENZA (carico resistivo) - HALOGEN / INCANDESCENT LAMPS (resistive load) LAMPES HALOGÈNES / INCANDESCENTES (charge resistive) - HALOGEN- UND GLÜHLAMPEN (Widerstandlast)
		TRASFORMATORI TRADIZIONALI (carico induttivo) - STANDARD TRANSFORMERS (inductive load) TRANSFORMATEURS STANDARD (charge inductive) - TRADITIONELLE TRANSFORMATOREN (Induktive Last) LED
		LED <i>(valore di fabbrica, default value, valeur prédéfinie, Standardwert)</i>
		LED + STL

IT - Compatibili con carichi LED. **EN -** Compatible with LED loads. **FR -** Compatibles avec les charges LED **DE -** Kompatibel mit LED Lasten.

* **IT -** Il buzzer emette un bip ad ogni pressione. **EN -** The buzzer will make a beep each press. **FR -** L'avertisseur sonore émet un bip à chaque appui. **DE -** Das Gerät quittiert jeden Druck mit einem Ton.

1.2

IT - Configurazione del valore minimo di intensità luminosa
EN - Configuration of the minimum level of light intensity
FR - Configuration du niveau le plus bas de l'intensité lumineuse
DE - Einstellen der minimalen Helligkeit

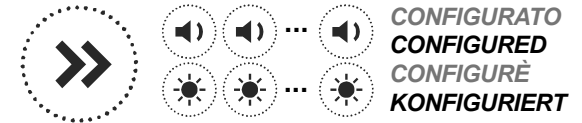
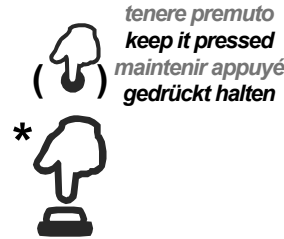
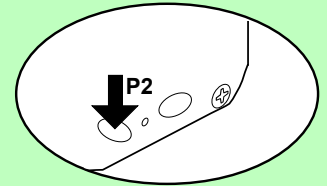

IT - Regolare l'intensità minima al livello desiderato.
 EN - Adjust the minimum brightness to the desired level.
 FR - Réglez la luminosité minimum de la valeur souhaitée.
 DE - Regeln Sie die Helligkeit auf den gewünschten Wert.

IT - Premere **1 volta** il tasto **P2** e tenere premuto.
 EN - Press **1 time** the button **P2** and keep it pressed.
 FR - Appuyer **1 fois** sur le bouton **P2** et le maintenir appuyé.
 DE - Drücken Sie **1 mal** die Taste **P2** und gedrückt halten.

1.3

IT - Attivazione/disattivazione memoria dell'ultimo valore di intensità luminosa
EN - Activation/deactivation of the memory of the last light intensity value
FR - Activation/désactivation de la mémoire de la dernière valeur d'intensité lumineuse
DE - Aktivierung/ Deaktivierung Speicherung letzter Wert der Lichtintensität

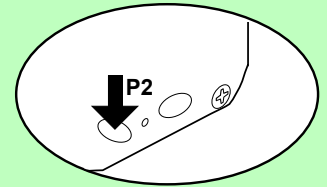

ATTIVAZIONE - ACTIVATION
ACTIVATION - AKTIVIERUNG



DISATTIVAZIONE - DEACTIVATION
DÉSACTIVATION - DEAKTIVIERUNG

IT - Premere **4 volte** il tasto **P2** e tenere premuto.
 EN - Press **4 times** the button **P2** and keep it pressed.
 FR - Appuyer **4 fois** sur le bouton **P2** et le maintenir appuyé.
 DE - Drücken Sie **4 mal** die Taste **P2** und gedrückt halten.

* IT - Il buzzer emette un bip ad ogni pressione. EN - The buzzer will make a beep each press. FR - L'avertisseur sonore émet un bip à chaque appui. DE - Das Gerät quittiert jeden Druck mit einem Ton.

IT - Dispositivi di comando wireless (versione con ricevitore radio integrato)

EN - Wireless command devices (version with built-in radio receiver)

FR - Dispositifs de commande sans fil (version avec récepteur intégré)

DE - Drahtlose Steuerungsgeräte (Ausführung mit integriertem Funkempfänger)

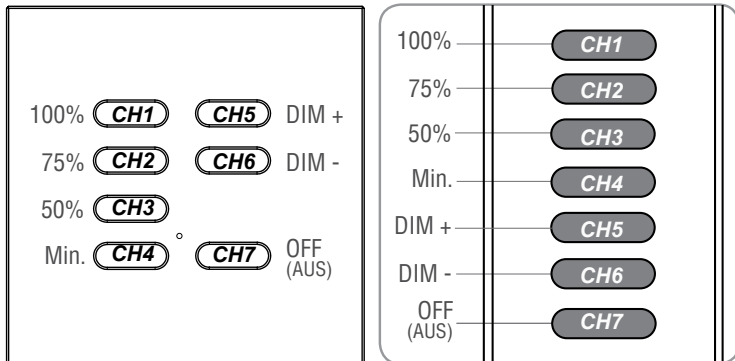

IT - Trasmettitore 7/42 canali
 EN - 7/42 channels transmitter
 FR - Emetteur à 7/42 canaux
 DE - 7/42-Kanal Sender

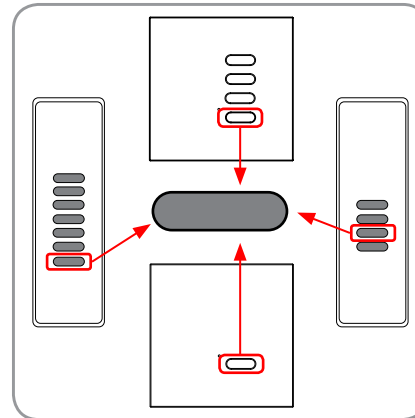

IT - Canale singolo di comando
 EN - Single command channel
 FR - Canal individuel de commande
 DE - Einzel- Kanal für Befehle

Green Mouse

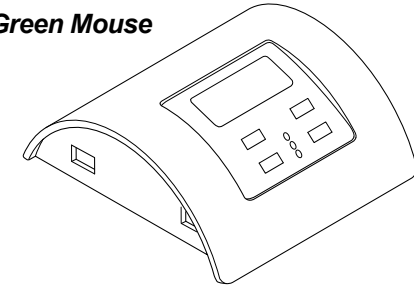

IT - Trasmettitore con sensore luce integrato

i Vedere le istruzioni del prodotto per dettagli.

EN - Transmitter with integrated light sensor

i See the product's instructions for details.

FR - Emetteur avec capteur de lumière intégré

i Voir la notice du produit pour plus d'informations.

DE - Sender mit integriertem Lichtsensor

i Siehe Anleitung des Produkts für Details.

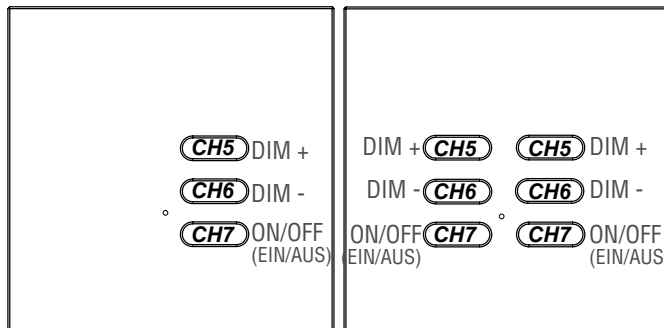



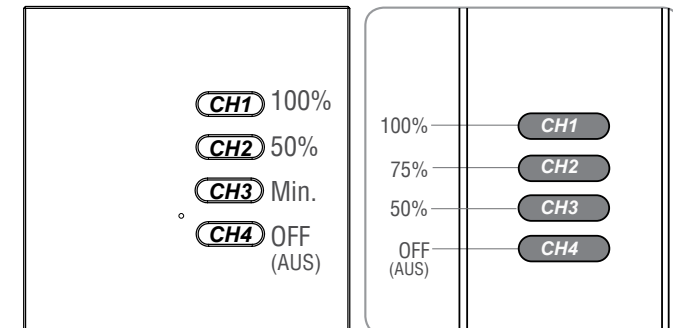
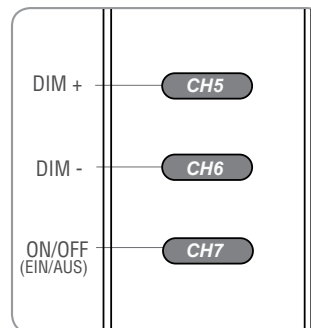



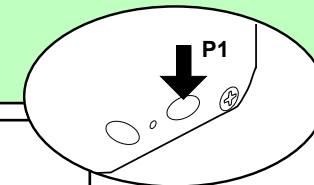































IT - Trasmettitore 3/6/18 canali
 EN - 3/6/18 channels transmitter
 FR - Emetteur à 3/6/18 canaux
 DE - 3/6/18-Kanal Sender



IT - Trasmettitore 4/24 canali
 EN - 4/24 channels transmitter
 FR - Emetteur à 4/24 canaux
 DE - 4/24-Kanal Sender



IT - TIPO DI MEMORIZZAZIONE EN - TYPE OF MEMORIZATION FR - TYPE DE MÉMORISATION DE - EINLERNUNGSART	P1	 tenere premuto keep it pressed maintenir appuyé gedrückt halten	 suono continuo continuous sound son continu Dauer-ton
IT - 7 canali (vedere p.5) EN - 7 channels (see p.5) FR - 7 canaux (voir p.5) DE - 7 Kanäle (siehe S.5)	* x1		
IT - 1 tasto: EN - 1 button: FR - 1 bouton: DE - 1 Taste:  <1 s  >1 s (EIN/AUS) ↑ ↓	* x2		
IT - 1 tasto con funzione ON EN - 1 button with function ON FR - 1 bouton avec fonction ON DE - 1 Taste mit Funktion EIN	* x3	 	
IT - 1 tasto con funzione OFF EN - 1 button with function OFF FR - 1 bouton avec fonction OFF DE - 1 Taste mit Funktion AUS	* x4	  	
IT - 3 canali (vedere p.5) EN - 3 channels (see p.5) FR - 3 canaux (voir p.5) DE - 3 Kanäle (siehe S.5)	* x5	   	
IT - Green Mouse (vedere p.5) EN - Green Mouse (see p.5) FR - Green Mouse (voir p.5) DE - Green Mouse (siehe S.5)	* x8	       	
IT - 4 canali (vedere p.5) EN - 4 channels (see p.5) FR - 4 canaux (voir p.5) DE - 4 Kanäle (siehe S.5)	* x9	        	

IT - Premere il tasto del trasmettitore relativo al codice da memorizzare.
EN - Press the button of the transmitter relative to the code to memorize.
FR - Appuyer sur le bouton de l'émetteur concernant le code à mémoriser.
DE - Drücken Sie die Sendertaste die auf den zu speichernden Code bezogen ist.









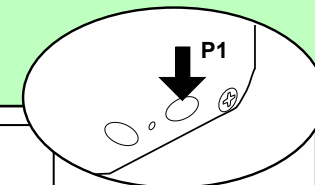

  ... 
suono intermittente
intermittent sound
son intermittent
intermittierender Ton

2.2

IT - Cancellazione codici radio
FR - Suppression des codes radio

EN - Radio codes deletion
DE - Löschung von Sendekanälen



<p>IT - TIPO DI CANCELLAZIONE EN - TYPE OF DELETION FR - TYPE DE SUPPRESSION DE - LÖSCHUNGSART</p>	<p>P1</p>	 <i>tenere premuto</i> keep it pressed <i>maintenir appuyé</i> gedrückt halten	  ... <i>suono intermittente</i> intermittent sound <i>son intermittent</i> intermittierender Ton	 <i>suono continuo</i> continuous sound <i>son continu</i> Dauerton
<p>IT - Singolo codice radio EN - Single radio code FR - Un seul code radio DE - Einzelner Sendekanal</p>	<p>* x6</p> 	 → 	<p>IT - Premere il tasto del trasmettitore relativo al codice da cancellare. EN - Press the button of the transmitter relative to the code to delete. FR - Appuyer sur le bouton de l'émetteur concernant le code à supprimer. DE - Drücken Sie die Sendertaste die auf den zu löschenden Code bezogen ist.</p>	
<p>IT - Tutti i codici radio EN - All the radio codes FR - Tous les codes radio DE - Alle Sendekanäle</p>	<p>* x7</p> 	 →  (10s.)		

2.3

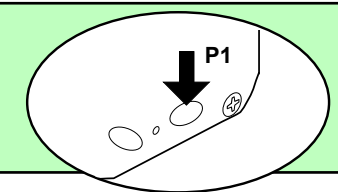

IT - Disabilitare un tasto di un trasmettitore 4 o 7/42 canali
EN - Disabling any button of a 4 or 7/42 channels transmitter
FR - Désactiver un bouton d'un émetteur à 4 ou à 7/42 canaux
DE - Deaktivierung einer Taste eines 4 oder 7/42 Kanal Senders









*











tenere premuto
keep it pressed
maintenir appuyé
gedrückt halten

 →  → 

DISABILITATO **DISABLED**
DÉSACTIVÉ **DEAKTIVIERT**

  ... 
  ... 

ABILITATO **ENABLED**
ACTIVÉ **AKTIVIERT**

IT - Premere 10 volte il tasto P1 e tenere premuto. Premere il tasto del trasmettitore da disabilitare.
EN - Press 10 times the button P1 and keep it pressed. Press the button of the transmitter to disable.
FR - Appuyer 10 fois sur le bouton P1 et le maintenir appuyé. Appuyer sur le bouton de l'émetteur à désactiver.
DE - Drücken Sie 10 mal die Taste P1 und gedrückt halten. Drücken Sie die zu deaktivierende Sendertaste.

* IT - Il buzzer emette un bip ad ogni pressione. EN - The buzzer will make a beep each press. FR - L'avertisseur sonore émet un bip à chaque appui. DE - Das Gerät quittiert jeden Druck mit einem Ton.

3.1

IT - Memorizzazione remota di ulteriori codici radio FR - Mémorisation à distance d'autres codes radio

EN - Remote memorization of further radio codes DE - Fern-Speicherung von weiteren Sendekanälen



IT - Il tasto **P3** si trova all'interno del trasmettitore. Il codice radio aggiunto avrà le stesse funzioni del codice usato per l'inserimento. La procedura è compatibile con qualsiasi tipo di trasmettitore.

EN - **P3** button is located inside the transmitter. The added radio code will have the same functions of the code used for the memorization. This procedure is compatible with any type of transmitter.

FR - Le bouton **P3** se trouve à l'intérieur de l'émetteur. Le code radio ajouté aura les mêmes fonctions que le code utilisé pour la mémorisation. La procédure est compatible avec n'importe quel type d'émetteur.

DE - Die Taste **P3** befindet sich im Inneren des Senders. Der hinzugefügte Sendekanal wird dieselben Funktionen des Codes haben welcher für die Einlernung verwendet wurde. Die Prozedur kann mit allen Arten von Sendern durchgeführt werden.

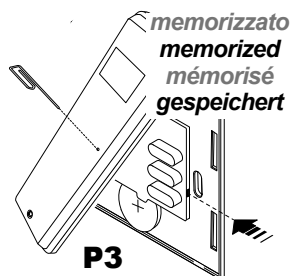

suono continuo
continuous sound
son continu
Dauerton



< 5 s

memorizzato
memorized
mémorisé
gespeichert



1 s

suono continuo
continuous sound
son continu
Dauerton



< 5 s

nuovo
new
nouveau
neu



suono intermittente
intermittent sound
son intermittent
intermittierender Ton



IT - Premere il tasto **P3** del trasmettitore **memorizzato**. Premere il tasto relativo ad un codice **memorizzato**. Premere il tasto relativo al **nuovo** codice. **EN** - Press the button **P3** of the **memorized** transmitter. Press the button relative to a **memorized** code. Press the button relative to the **new** code. **FR** - Appuyer sur le bouton **P3** de l'émetteur **mémorisé**. Appuyer sur le bouton concernant un code **mémorisé**. Appuyer sur le bouton concernant le **nouveau** code. **DE** - Drücken Sie die Taste **P3** des **gespeicherten** Senders. Drücken Sie die auf den **gespeicherten** Code bezogene Taste. Drücken Sie die auf den **neuen** Code bezogene Taste.

3.2

IT - Cancellazione remota di un codice radio FR - Suppression à distance d'un code radio

EN - Remote deletion of a radio code DE - Fern-Löschung eines Sendekanals



IT - Il tasto **P3** si trova all'interno del trasmettitore.

EN - **P3** button is located inside the transmitter.

FR - Le bouton **P3** se trouve à l'intérieur de l'émetteur. **DE** - Die Taste **P3** befindet sich im Inneren des Senders.

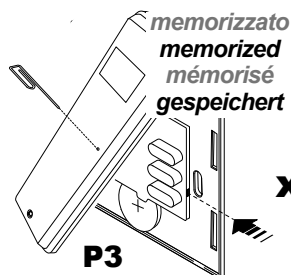

suono continuo
continuous sound
son continu
Dauerton



1 s



suono intermittente
intermittent sound
son intermittent
intermittierender Ton



< 5 s

suono continuo
continuous sound
son continu
Dauerton



IT - Premere tre volte il tasto **P3** del trasmettitore **memorizzato**. Premere il tasto relativo al codice da cancellare. **EN** - Press three times the button **P3** of the **memorized** transmitter. Press the button relative to the code to delete. **FR** - Appuyer trois fois sur le bouton **P3** de l'émetteur **mémorisé**. Appuyer sur le bouton concernant le code à supprimer. **DE** - Drücken Sie drei mal die Taste **P3** des **gespeicherten** Senders. Drücken Sie die auf den zu löschenden Code bezogene Taste.

4

IT - Modifica dei valori di luminosità preimpostati di un trasmettitore 4 o 7/42 canali

EN - Modification of the preset light values of a 4 or 7/42 channel transmitter

FR - Modification des valeurs de luminosité préréglées d'un émetteur 4 ou 7/42 canaux

DE - Änderung der voreingestellten Helligkeitswerte eines 4 oder 7/42-Kanal Senders



IT - Se un trasmettitore con valori di luminosità modificati viene usato nella memorizzazione remota (pagina 8), il trasmettitore aggiunto avrà gli stessi valori modificati.
EN - If any transmitter with modified light values is used in the remote memorization (page 8), the added transmitter will have the same modified values.
FR - Si un émetteur avec valeurs de luminosité modifiées est utilisé dans la mémorisation via radio (page 8), l'émetteur ajouté aura les mêmes valeurs modifiées.
DE - Wenn ein Sender mit geänderten Helligkeitswert für die Fern- Einlernung (Seite 8) verwendet wird, wird der Sender dieselben geänderten Werte haben.

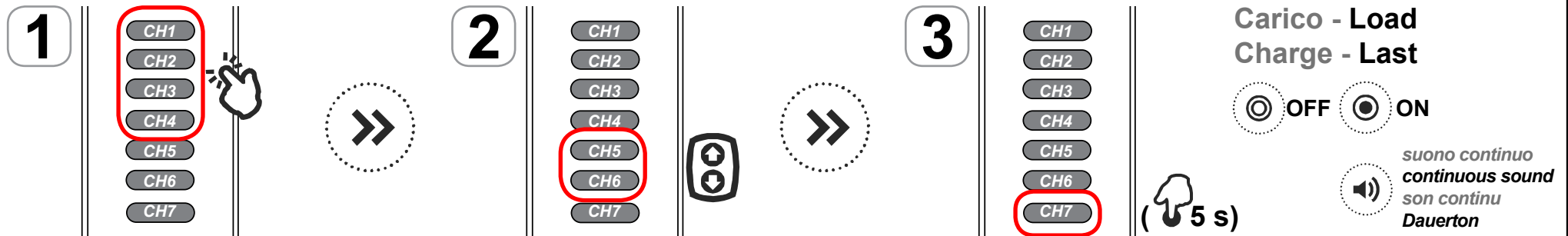

IT - 1. Premere il tasto relativo al valore da modificare (CH1..CH4). 2. Regolare il valore con i tasti CH5 e CH6. 3. Premere e tenere premuto CH7 per 5s.
EN - 1. Press the button relative to the value to modify (CH1..CH4). 2. Adjust the value with buttons CH5 and CH6. 3. Press CH7 and keep it pressed for 5s.
FR - 1. Appuyer sur le bouton concernant la valeur à modifier (CH1..CH4). 2. Régler la valeur par mois des boutons CH5 et CH6. 3. Appuyer et maintenir appuyé CH7 pour 5s.
DE - 1. Drücken Sie die Taste bezüglich des zu ändernden Werts (CH1..CH4). 2. Stellen Sie den Wert mit den Tasten CH5 und CH6 ein. 3. CH7 drücken und halten Sie 5s. lang gedrückt.

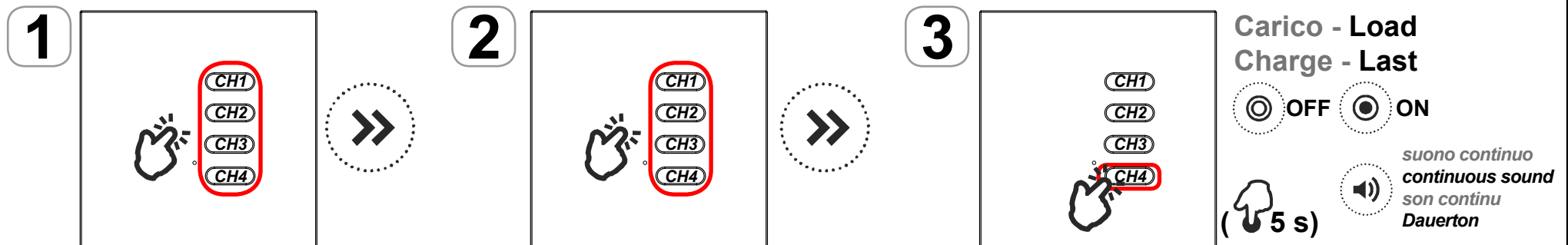

IT - 1. Premere il tasto relativo al valore da modificare (CH1..CH4). 2. Regolare il valore tenendo premuto lo stesso tasto. 3. Premere e tenere premuto CH4 per 5s.
EN - 1. Press the button relative to the value to modify (CH1..CH4). 2. Adjust the value keeping pressed the same button. 3. Press CH4 and keep it pressed for 5s.
FR - 1. Appuyer sur le bouton concernant la valeur à modifier (CH1..CH4). 2. Régler la valeur en gardant appuyé le même bouton. 3. Appuyer et maintenir appuyé CH4 pour 5s.
DE - 1. Drücken Sie die Taste bezüglich des zu ändernden Werts (CH1..CH4). 2. Stellen Sie den Wert durch Gedrückt Halten derselben Taste ein. 3. CH4 drücken und halten Sie 5s. lang gedrückt.



(IT) AVVERTENZE: LEGGERE ATTENTAMENTE IL PRESENTE MANUALE PRIMA DI INSTALLARE O METTERE IN SERVIZIO IL PRODOTTO. CONSERVARE LE ISTRUZIONI PER FUTURA CONSULTAZIONE.

INSTALLAZIONE DEL PRODOTTO

Il prodotto in oggetto deve essere installato, messo in servizio e controllato periodicamente solo da personale tecnico qualificato nel rispetto delle normative vigenti riguardanti le apparecchiature elettriche. Il prodotto deve essere posizionato all'interno di una scatola di derivazione elettrica idonea. L'installazione non conforme, l'errata regolazione o l'alterazione del prodotto possono essere causa di incendio, shock elettrico e lesioni personali anche gravi. Il produttore declina qualsiasi responsabilità in caso di danni derivanti da errata installazione o utilizzo non conforme del dispositivo. **Attenzione: all'accensione il ricevitore riprende la condizione precedente allo spegnimento.**

CONNESSIONI ELETTRICHE

Tutti i collegamenti devono essere previsti per un'alimentazione generale monofase 230Vac ed il relativo collegamento di Terra. Per la disconnessione dalla rete utilizzare un interruttore onnipolare con un'apertura dei contatti di almeno 3,5 mm. Predisporre **tutti i dispositivi di sicurezza necessari** ed utilizzare materiali di collegamento idonei secondo le attuali normative sulla sicurezza elettrica. I cavi di collegamento devono avere una sezione adeguata al carico applicato. **Attenzione:** se il cavo di alimentazione è danneggiato, esso deve essere sostituito da persona qualificata, in modo da prevenire ogni rischio.

INFORMAZIONI DI SICUREZZA

Non operare nelle zone ad alto voltaggio della scheda, quando il prodotto è alimentato. Utilizzare l'apparecchiatura solo con carichi che garantiscano un funzionamento prolungato in completa sicurezza. La ricezione radio del dispositivo può essere disturbata se si hanno nell'ambiente emissioni elettromagnetiche provenienti da altre apparecchiature che trasmettono sulla stessa frequenza oppure se il dispositivo viene schermato da parti metalliche.

SMALTIMENTO DEL PRODOTTO

Alla fine della vita utile, l'apparecchio non deve essere smaltito come rifiuto domestico, ma conferito in un centro di raccolta rifiuti elettrici ed elettronici. L'utente è l'unico responsabile dello smaltimento dell'apparecchio a norma di legge, alla fine della vita utile del medesimo. L'inadempienza è punibile ai sensi della legge applicabile in materia di smaltimento dei rifiuti.

Con la presente Teleco Automation s.r.l. dichiara che il prodotto è conforme ai requisiti essenziali, ed alle altre disposizioni pertinenti, stabilite dalla direttiva 1999/5/CE. La dichiarazione di conformità può essere consultata sul sito: www.telecoautomation.com/ce. **Nell'ottica di un continuo sviluppo dei propri prodotti, il produttore si riserva il diritto di apportare modifiche a dati tecnici e prestazioni senza preavviso.**



(EN) WARNING: READ CAREFULLY THIS INSTRUCTIONS BEFORE INSTALLING AND COMMISSIONING THE PRODUCT. SAVE THESE INSTRUCTIONS FOR FUTURE REFERENCE.

PRODUCT INSTALLATION

The product at issue must be installed, commissioned and maintained only by licensed and authorised people, respecting the laws concerning the electrical installations. The product must be placed inside a suitable flush mounting box. Not conforming installations, wrong adjustments or product alterations may cause fire, electric shock, or personal injuries. The manufacturer is not responsible for any damage due to wrong installation or improper use. **Attention: at the power-on the device resumes the status it had before the turning-off.**

ELECTRICAL CONNECTIONS

All the connections must be rated for a single-phase 230Vac power supply, with the relative Earth connection. For the disconnection from the power line, use an all-pole switch with contacts having a dimension of at least 3,5mm. Arrange **all the necessary safety devices** and use only materials complying with the standard of electrical installations. The cable must have a section properly rated according to the load connected. **Attention:** If any cable is damaged, it must be immediately replaced by a qualified person in order to avoid any hazard. **manufacturer reserves the right for changing technical data and features without prior notice.**

SAFETY INFORMATION

Do not operate in the high voltage area of the electronic board, when it is supplied. Use the product only in combination with devices which can guarantee a safe extended time functioning. The radio signal reception of the device could be disturbed by the presence of electrical disturbances being transmitted by other appliances working on the same frequency or if the product is somehow shielded by metal parts.

PRODUCT DISPOSAL

At the end of this product's useful life, it must not be disposed of as domestic waste, but must be taken to a collection centre for waste electrical and electronic equipment. It is the user's responsibility to dispose of this appliance through the appropriate channels at the end of its useful life. Failure to do so may incur the penalties established by laws governing waste disposal.

Hereby Teleco automation s.r.l. declares that the product complies with the essential requirements and other relevant provisions, established by the Directive 1999/5/EC. The declaration of conformity can be consulted on the web site: www.telecoautomation.com/ce. **In the view of a constant development of their products, the manufacturer reserves the right for changing technical data and features without prior notice.**



(FR) AVERTISSEMENTS: LISEZ ATTENTIVEMENT CE MANUEL AVANT D'INSTALLER OU DE METTRE EN FONCTION L'APPAREIL. CONSERVEZ LES NOTICES POUR TOUTE CONSULTATION FUTURE.

INSTALLATION DU PRODUIT

Le produit en objet doit être installé, mis en service et vérifié périodiquement seulement par des techniciens qualifiés, conformément aux normes en vigueur pour les appareillages électriques. Le produit doit être installé dans une boîte d'encastrement appropriée. Une installation pas conforme, un mauvais réglage ou une altération inadéquate du produit pourraient entraîner des incendies, chocs électriques et blessures graves. Le fabricant décline toute responsabilité en cas de dommages qui pourraient survenir à cause d'une mauvaise installation ou d'une utilisation pas conforme du produit. **Attention : a la mise sous-tension, le dernier état avant extinction (ON ou OFF) est restauré.**

BRANCHEMENTS ÉLECTRIQUES

Tous les branchements doivent être prévus pour une alimentation générale en monophasé 230Vac et pour le raccordement de terre. Pour la déconnexion du réseau, utiliser un interrupteur onnipolaire avec une ouverture des contacts de minimum 3,5 mm. Installer **tous les dispositifs de sécurité requis** et utiliser des matériaux de branchement aptes à garantir une isolation conforme aux normes de sécurité électrique. Les câbles de connexion doivent avoir une section adéquate à la charge appliquée. **Attention :** si le câble d'alimentation est endommagé, il doit être remplacé seulement par le constructeur ou par son service technique ou par du personnel qualifié afin de prévenir tous risques.

AVERTISSEMENTS DE SÉCURITÉ

Ne pas opérer dans les composant à haute tension du produit quand il est sous tension. Utiliser l'appareillage seulement avec des charges dont le fonctionnement ne constitue pas du danger s'elles restent actives en permanence. La réception radio du dispositif peut être perturbée si dans l'environnement il y a des perturbations radioélectrique créées par d'autres appareils qui transmettent sur la même bande de fréquence ou si l'appareil se trouve dans un boîtier avec parties métalliques.

ÉLIMINATION DU PRODUIT

À la fin de la durée de vie utile de ce produit, il ne doit pas être éliminé comme tout autre déchet domestique. En effet, il doit être déposé dans un centre de collecte des déchets d'équipements électriques et électroniques. Il est de la responsabilité de l'utilisateur de se débarrasser de cet appareil par les voies appropriées à la fin de sa vie utile. Ne pas respecter cette consigne peut vous soumettre à des sanctions établies par les lois régissant l'élimination des déchets.

La Société Teleco Automation s.r.l. déclare que le produit est conforme aux conditions essentielles, et aux autres dispositions applicables, établies par la directive 1999/5/CE. La déclaration de conformité peut être consultée sur le site internet www.telecoautomation.com/ce. **Dans l'optique d'un développement continu de ses produits, le constructeur se réserve le droit d'apporter sans préavis des modifications aux données techniques et aux prestations.**



(DE) ACHTUNG: BITTE LESEN SIE DIESE ANLEITUNG SORGFÄLTIG VOR DER INSTALLATION ODER INBETRIEBNAHME DES GERÄTS. BETRIEBSANLEITUNG FÜR ZUKÜNFTIGE VERWENDUNG AUFBEWAHREN.

INSTALLATION DES PRODUKTS

Das Produkt darf nur von qualifiziertem technischen Personal unter Einhaltung der geltenden Gesetze bezüglich elektrischer Geräte installiert, in Betrieb gesetzt und regelmäßig gewartet werden. Das Produkt muss in eine geeignete Anschlussdose platziert werden. Eine unsachgemäße Installation, Einstellung oder Modifikation des Produkts kann zu Brandfällen, elektrischem Schock und schweren Verletzungen führen. Der Hersteller haftet nicht für Schäden, die durch unsachgemäßer Installation und Gebrauch verursacht werden. **Achtung: Mit power-on- reset werden die Einstellungen vor dem Abschalten wieder hergestellt.**

ELEKTRISCHE ANSCHLÜSSE

Alle Verbindungen müssen auf einphasigen Wechselstrom mit 230 Volt und dem jeweiligen Masseanschluss ausgelegt sein. Für die Abtrennung vom Netz ist ein allpoliger Schalter mit einer Kontaktöffnung von mindestens 3,5 mm zu verwenden. Für den Anschluss sind geeignete Materialien zu verwenden, die eine Isolierung entsprechend den geltenden elektrischen Sicherheitsbestimmungen gewährleisten. Der Querschnitt der Verbindungskabel muss für die entsprechende Last geeignet dimensioniert sein. **Achtung:** Falls das Stromkabel beschädigt sein sollte, muss es vom Hersteller oder von technischem Personal oder einer qualifizierten Person ersetzt werden um Risiken zu vermeiden.

SICHERHEITSINFORMATIONEN

Arbeiten Sie nicht in unmittelbarer Nähe des Hochspannungsbereich wenn das Produkt an den Stromkreis angeschlossen ist. Verwenden Sie das Gerät nur mit Lasten die einen kontinuierlichen Betrieb in kompletter Sicherheit garantieren. Der Funkempfang des Geräts kann durch Funkstörungen durch andere Geräte in der Umgebung, die auf der gleichen Frequenz senden oder durch Abdeckung oder Abschirmung des Geräts durch Metallteile beeinträchtigt werden.

ENTSORGUNG DES GERÄTS

Nach dem Ablauf der Nutzungszeit des Gerätes darf es nicht ohne Weiteres im Hausmüll entsorgt werden, sondern muss zu einer entsprechenden Entsorgungsstelle für elektronische Geräte gebracht werden. Es unterliegt der Verantwortung des Endverbrauchers, dieses Gerät nach dem Ablauf der Nutzungszeit entsprechend zu entsorgen. Falls dies nicht befolgt wird, kann dies zu Strafen führen, die im Entsorgungsgesetz festgelegt sind.

Hiermit erklärt Teleco Automation s.r.l., dass das Produkt den Anforderungen und den einschlägigen Bestimmungen der Richtlinie 1999/5/CE entspricht. Die Konformitätserklärung kann im Internet unter www.telecoautomation.com/ce eingesehen werden. **Im Zuge einer kontinuierlichen Weiterentwicklung der Produkte behält sich der Hersteller das Recht vor technische Daten und Funktionen ohne vorherige Ankündigung zu ändern.**



IT - Specifiche tecniche
FR - Spécifications techniques

EN - Technical specifications
DE - Technische Daten

Alimentazione - Power supply - Alimentation - Stromversorgung	230Vac (50-60Hz)
Potenza massima uscita - Max. output power Puissance maximale sortie - Max. Ausgänge Leistung	250W (R), 250VA (L,C), 100W (LED)
Potenza minima uscita - Min. output power Puissance minimale sortie - Min. Ausgänge Leistung	25W (R), 25VA (L,C), 7W (LED)
<i>IT - I cavi di collegamento devono avere una sezione adeguata al carico massimo applicato in uscita, e ai dispositivi supplementari collegati agli ingressi. EN - The connection cables must have a section suitable to the maximum load applied to the output, and to the additional devices connected to the input. FR - Les câbles de connexion doivent avoir une section appropriée à la charge maximale appliquée en sortie et aux dispositifs supplémentaires connectés aux entrées. DE - Die Verbindungskabel müssen einen Durchmesser haben der angemessen ist für die maximale Ausgangelast und für die weiteren Geräte die an den Eingängen angeschlossen sind.</i>	
Grado di protezione - Protection rating - Degré de protection - Schutzart	IP20
Temperatura di funzionamento - Operating temperature range Température de fonctionnement - Umgebungstemperatur im Betrieb	-20°C / +50°C
Frequenza ricezione - Reception frequency Fréquence de réception - Empfangsfrequenz	868.3 MHz (TVDLC868A01) 916 MHz (TVDLC916A01) ----- (TVDLC000A01)
Capacità memoria radio (trasmettitori) - Radio memory capability (transmitters) Capacité mémoire radio (émetteurs) - Speicherbare Sender	16 (TVDLC868A01, TVDLC916A01)
Dimensioni (mm) - Dimensions (mm) - Dimensions (mm) - Abmessungen (mm)	50 x 50 x 25

Teleco Automation S.r.l.
Italy
Tel. +39.0438.388511
Fax +39.0438.388536
info@telecoautomation.com

Teleco Automation France
France
Tel. +33.(0)472.145080
Fax +33.(0)472.140503
info@telecofrance.com

Teleco Automation GmbH
Germany
Tel. +49.(0)8122.9563024
Fax +49.(0)8122.9563026
info.de@telecoautomation.com

Teleco Automation Oceania Pty Ltd
Australia
Tel. +61.(07)5502.7801
info@telecoautomation.com.au



www.telecoautomation.com