

RADIO RECEIVER FOR 12/24Vdc LED STRIPS COMMON ANODE - CONTROLLER FOR TUNABLE WHITE AND DIMMER -

Product codes: **TVSTRDW868ST24** Master 2x4A (868Mhz) **TVRGBD000ST24** Slave 4A
TVSTRDW916ST24 Master 2x4A (916Mhz)

The product has 2 output for the connection of a cool white LED strip and a warm white LED strip.
 It allows to adjust the "temperature" of the colour, mixing the output from cool white to warm white.

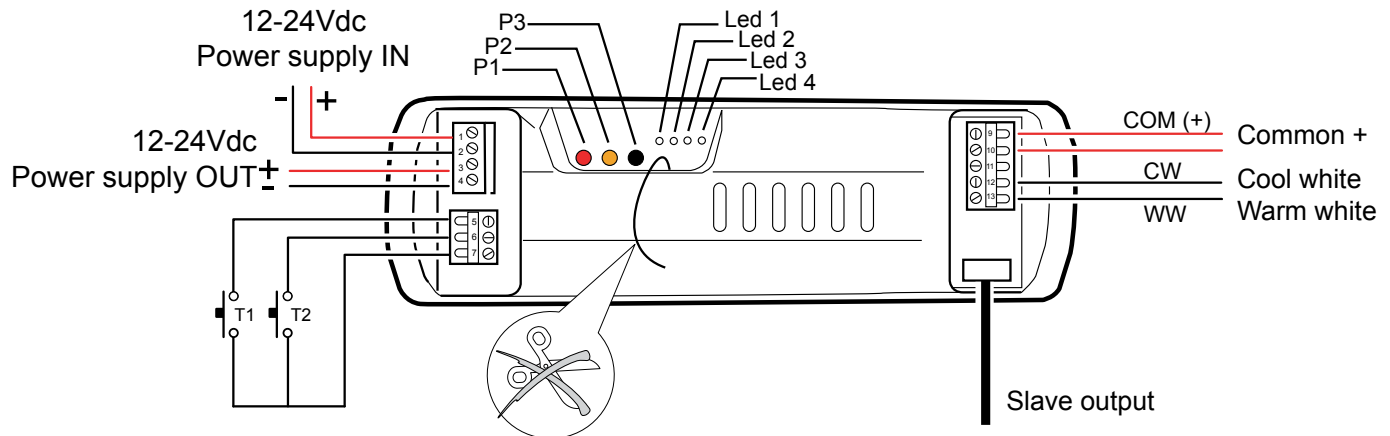

1 - LED wiring

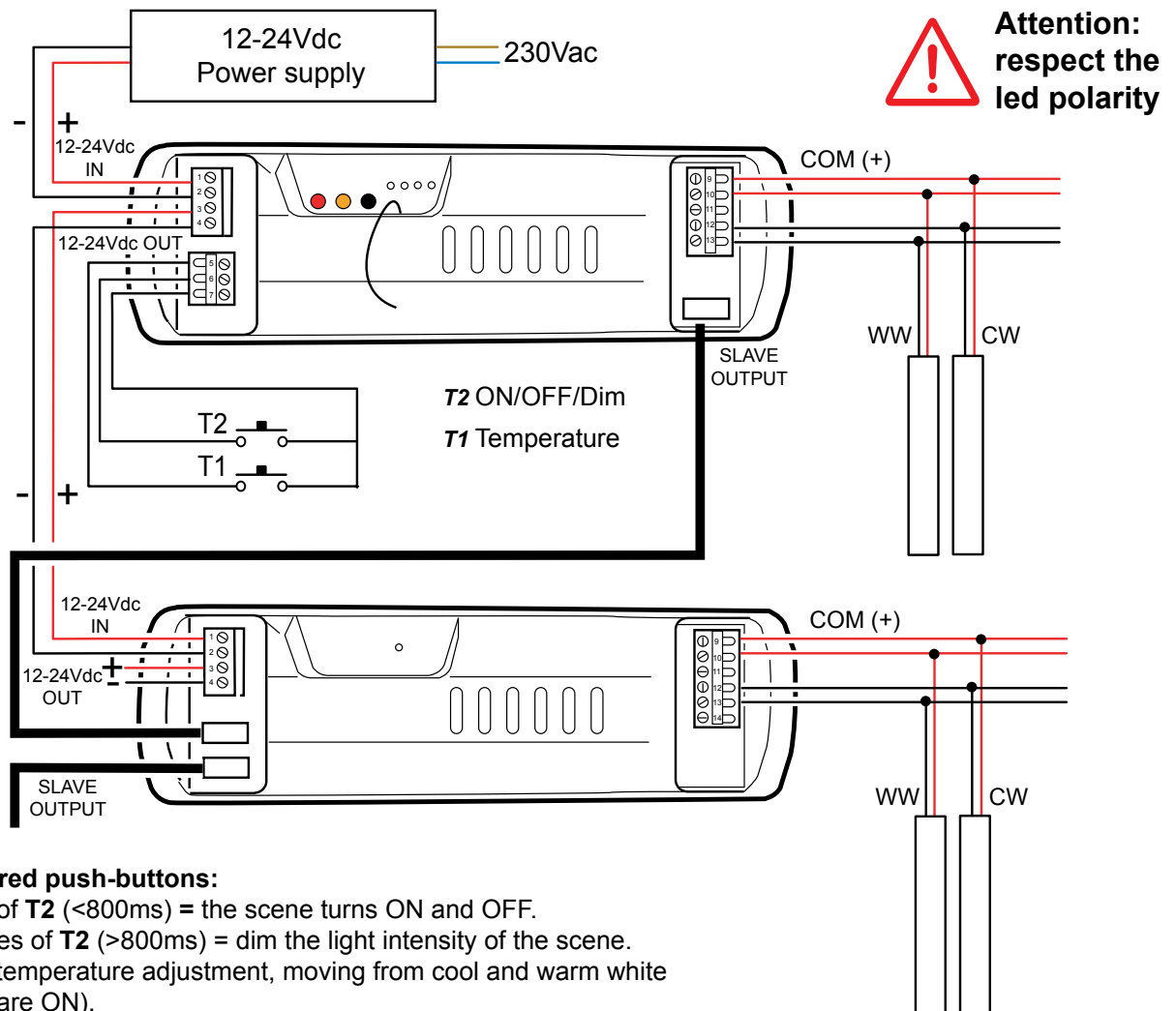

2 - Memorization of 7 channels transmitters

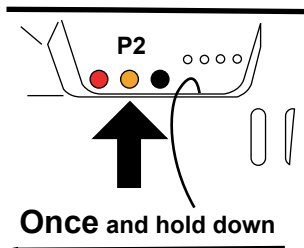

1- Press the push button **P2 once and hold** it down, the buzzer will make a beep and then sound continuously.

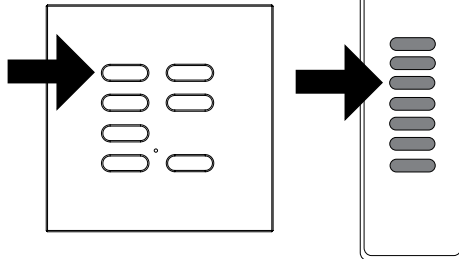

2- During the sound press any button of the 7 channels transmitter which has to be memorized. The memorization is indicated by the intermittently sound of the buzzer. All the buttons of the transmitter are automatically memorized.

Function available only for 7 or 42 channels transmitters

SCENE 1	CH1	<input type="checkbox"/>	<input type="checkbox"/>	CH5	> Cool white
SCENE 2	CH2	<input type="checkbox"/>	<input type="checkbox"/>	CH6	> Warm white
SCENE 3	CH3	<input type="checkbox"/>			
SCENE 4	CH4	<input type="checkbox"/>	<input type="checkbox"/>	CH7	OFF

Short presses of the buttons CH1..4 command the memorized scenes.
Longer presses allow to dim the light intensity of the selected scene.

Short or long presses of the buttons CH5 and CH6 adjust the “temperature” of the colour in both directions.

Short press of CH7 turns OFF the output, with fade effect.

2.1 - To change the preset scenes of the 7 channels transmitters

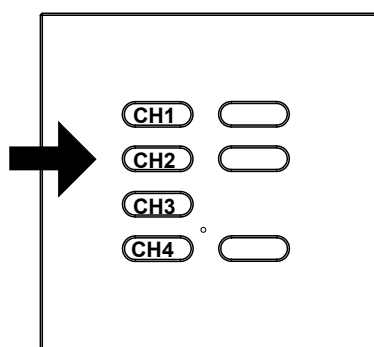

press the scene to modify

1- Press the button related to the scene to modify

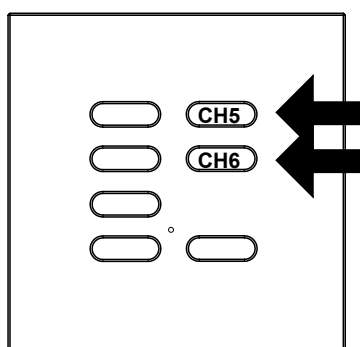

adjust new value

2- Adjust the new value with the buttons CH5 and CH6

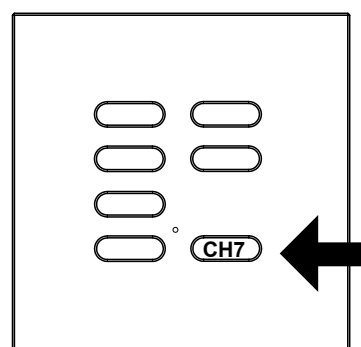

press and hold more than 5s

3- Press the button CH7 and hold it down for 5 sec. Light turns off. After 5 sec. buzzer makes a beep and the light turns on at the new value.

2.2 - Reset the scenes to the factory values

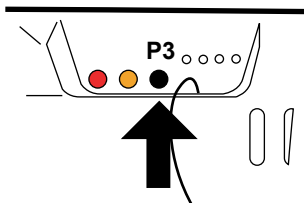

- 1 - Turn off the light.
- 2 - Press **three times** the button **P3** and hold it down for 10 seconds.
- 3 - After 10 sec. the buzzer makes a beep and the light flashes once.

3 times and hold down 10s

3 - Memorization of any transmitter button with ON function (ON at the previous scene)

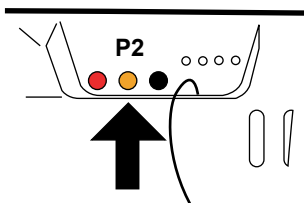

2 times and hold down

- 1- Press the push button **P2** **two times and hold** it down, the buzzer will make a beep each time and then sound continuously.

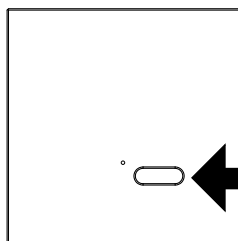

- 2- During the sound press the button to memorize; the memorization is indicated by the intermittently sound of the buzzer.

4 - Memorization of any transmitter button with OFF function

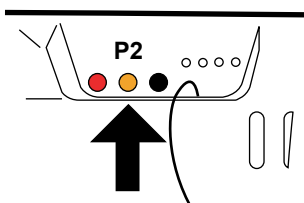

3 times and hold down

- 1- Press the push button **P2** **three times and hold** it down, the buzzer will make a beep each time and then sound continuously.

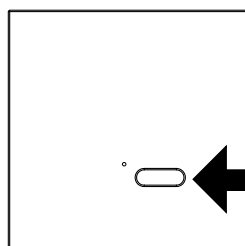

- 2- During the sound press the button to memorize; the memorization is indicated by the intermittently sound of the buzzer.

5 - Memorization of a pair of transmitter buttons

With short pulses (< 800ms) of the first button of the pair, the scene turns on and off.

With longer presses (> 800ms) it's possible to dim the light intensity of the scene.

The second button of the pair is used for cyclical temperature adjustment, moving from cool and warm white (if the output are ON). The new value is automatically memorized at the end of the adjustment.

In case of 3 channels transmitter or CH5, CH6, CH7 buttons of a 7 channels transmitter, temperature is adjusted in two directions using CH5 and CH6. CH7 has the same function of the first button of any pair.

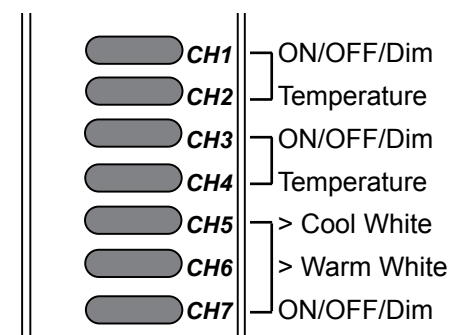

7 channels transmitter

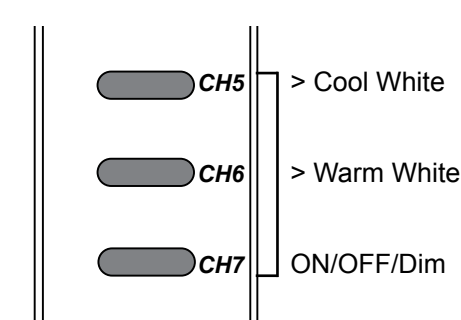

3 channels transmitter

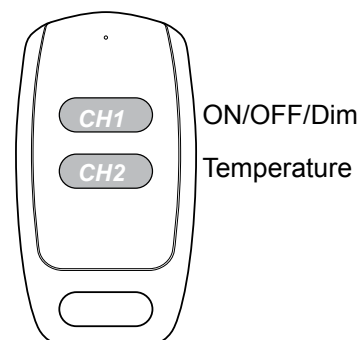

2 channels transmitter

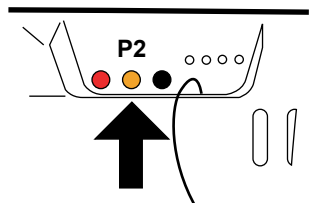

4 times and hold down

- 1- Press the push button **P2** **four times and hold** it down, the buzzer will make a beep each time and then sound continuously.

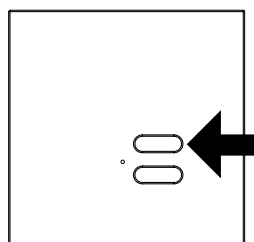

- 2- During the sound press the button to memorize; the memorization is indicated by the intermittently sound of the buzzer.

6.1 - Memorization of any transmitter button with On/Off/Dim function for SCENE 1

Short pulses (<800ms) = scene ON/OFF, longer presses (>800ms) = dim the light intensity.

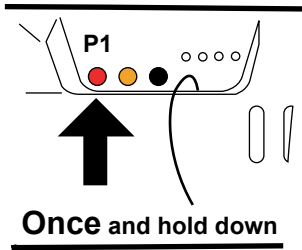

1- Press the push button **P1 once and hold** it down, the buzzer will make a beep each time and then sound continuously.

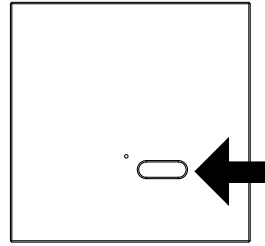

2- During the sound press the button to memorize; the memorization is indicated by the intermittently sound of the buzzer.

6.2 - Memorization of any transmitter button with On/Off/Dim function for SCENE 2

Short pulses (<800ms) = scene ON/OFF, longer presses (>800ms) = dim the light intensity.

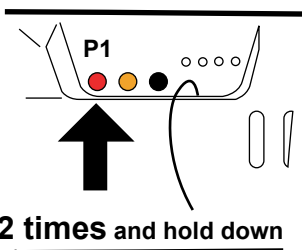

1- Press the push button **P1 two times and hold** it down, the buzzer will make a beep each time and then sound continuously.

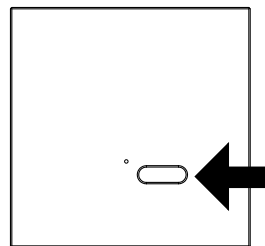

2- During the sound press the button to memorize; the memorization is indicated by the intermittently sound of the buzzer.

6.3 - Memorization of any transmitter button with On/Off/Dim function for SCENE 3

Short pulses (<800ms) = scene ON/OFF, longer presses (>800ms) = dim the light intensity.

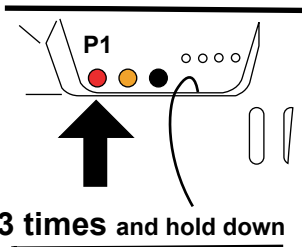

1- Press the push button **P1 three times and hold** it down, the buzzer will make a beep each time and then sound continuously.

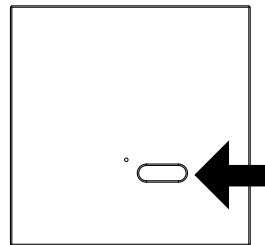

2- During the sound press the button to memorize; the memorization is indicated by the intermittently sound of the buzzer.

6.4 - Memorization of any transmitter button with On/Off/Dim function for SCENE 4

Short pulses (<800ms) = scene ON/OFF, longer presses (>800ms) = dim the light intensity.

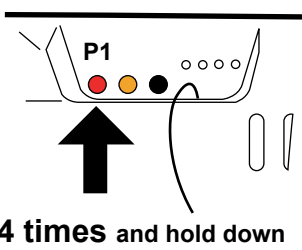

1- Press the push button **P1 four times and hold** it down, the buzzer will make a beep each time and then sound continuously.

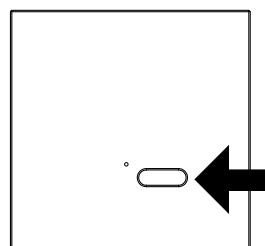

2- During the sound press the button to memorize; the memorization is indicated by the intermittently sound of the buzzer.

7 - Copying the function of a transmitter to a new transmitter

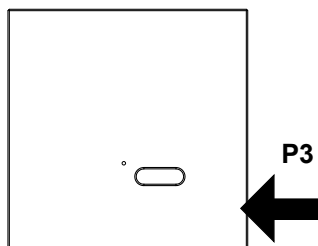

1- Press the button **P3** of the **already memorized transmitter**. The enabled receiver sound continuously.

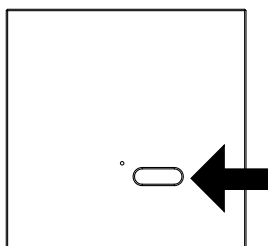

2- Within 5 seconds press a button of the **already memorized transmitter** from which the function has to be copied. The buzzer will interrupt the sound for 1 sec., then starts again for 5 seconds.

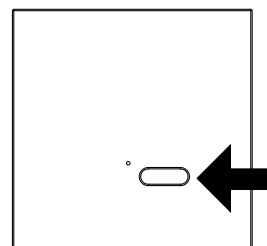

3- During the sound press the button of the **new transmitter** which has to be memorized; the memorization is indicated by the intermittently sound of the buzzer.

8 - Deleting a transmitter

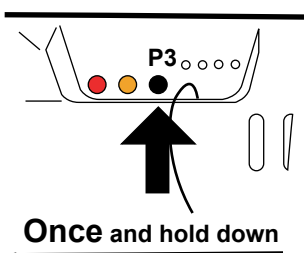

1- Press the push button **P3 once and hold** it down, the buzzer will make a beep each time and then sound slowly and intermittently.

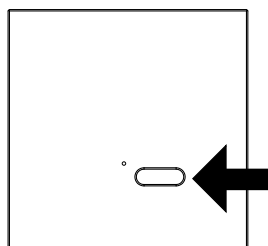

2- During the sound press the button which has to be deleted; the deletion is indicated by the continuously sound of the buzzer.

8.1 - Deleting a transmitter with an already memorized transmitter

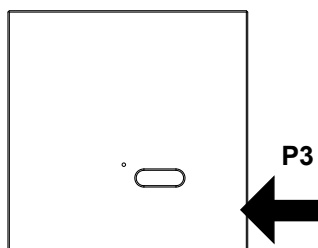

1- Press the button **P3** of the **transmitter**. The enabled receiver emits a slow intermittent sound.

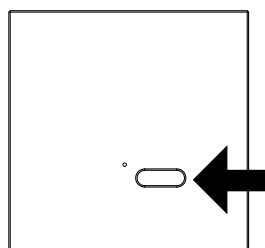

2- Within 5 sec. press the button to delete, the buzzer emits a continuous sound to confirm the deletion.

8.2 - Deleting all the transmitters

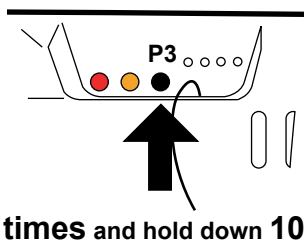

1- Press the push button **P3 two time and hold** it down, the buzzer will make a beep each time and then sound quickly and intermittently.

2- Hold down the push button for 10 sec., at the end the buzzer will sound continuously by indicating that the memory has been cancelled.

9 - Memory activation/ deactivation of the last value of light intensity

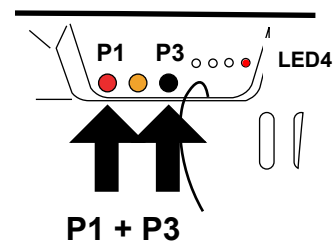

ACTIVATION

Press **P1+P3**

- led 4 turns ON
- the output blink twice
- the buzzer sounds

DEACTIVATION

Press **P1+P3**

- led 4 turns OFF
- the output blink three times
- the buzzer sounds

Mounting

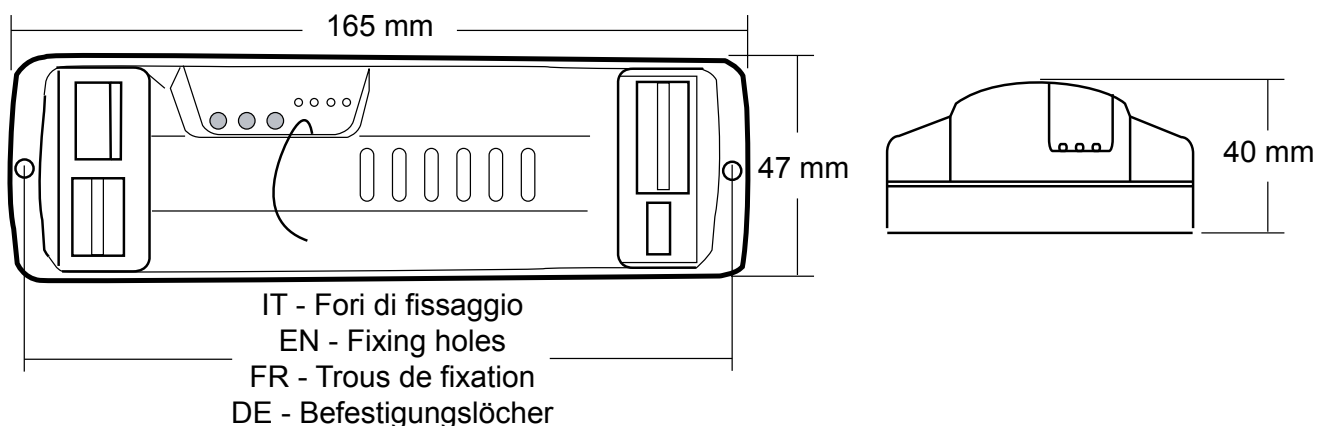

Warnings

Connect the power supplier and the LED correctly to the receiver before connecting the power supplier to the mains supply. A faulty connection of the LED diodes (polarity inversion) could damages them, therefore pay attention during their connection by respecting the polarity. The general power supply of the device has to be provided by a power supplier which can supply the needed power and voltage. The power supply must be compliant with IEC60950-1 and must be protected against short circuit and overvoltage. At the power-on the device resumes the status it had before the turning-off. The product must not be enclosed or placed with insulating material such as glass wool, polystyrene or similar materials. Let the housing to be well-ventilated. Hereby Teleco automation s.r.l. declares that the product complies with the essential requirements and other relevant provisions, established by the Directive 1999/5/EC. The declaration of conformity can be consulted on the web site: www.telecoautomation.com/ce. In the view of a constant development of their products, the manufacturer reserves the right for changing technical data and features without prior notice.

TECHNICAL SPECIFICATIONS

-Power supply	12 Vdc to 24 Vdc	-Reception frequency	868.3 MHz (TVSTRDW868ST24)
-Max. power for each output	2 x 4A		916 MHz (TVSTRDW916ST24)
-Cable sections in input	2,5 mm ² with maximum load	-Operating temperature range	-20° - +50°C

The connection cables must have a section suitable to the maximum load applied to the output, and to the additional devices connected to the input.

- Possibility to memorize up to 42 standard transmitters.

Teleco Automation S.r.l.
Italy
Tel. +39.0438.388511
Fax +39.0438.388536
info@telecoautomation.com

Teleco Automation France
France
Tel. +33.(0)472.145080
Fax +33.(0)472.140503
info@telecofrance.com

Teleco Automation GmbH
Germany
Tel. +49.(0)8122.9563024
Fax +49.(0)8122.9563026
info.de@telecoautomation.com

Teleco Automation Oceania Pty Ltd
Australia
Tel. +61.(07)5502.7801
info@telecoautomation.com.au



www.telecoautomation.com