

## RADIO DIMMER RADIO RECEIVER 0-10V

**Product code:**

**TVDMC868xx10** Dimmer for the manual or radio control of 0-10V loads

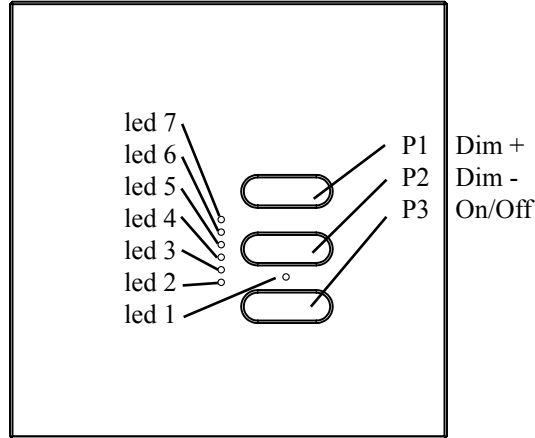

### 1- Connections

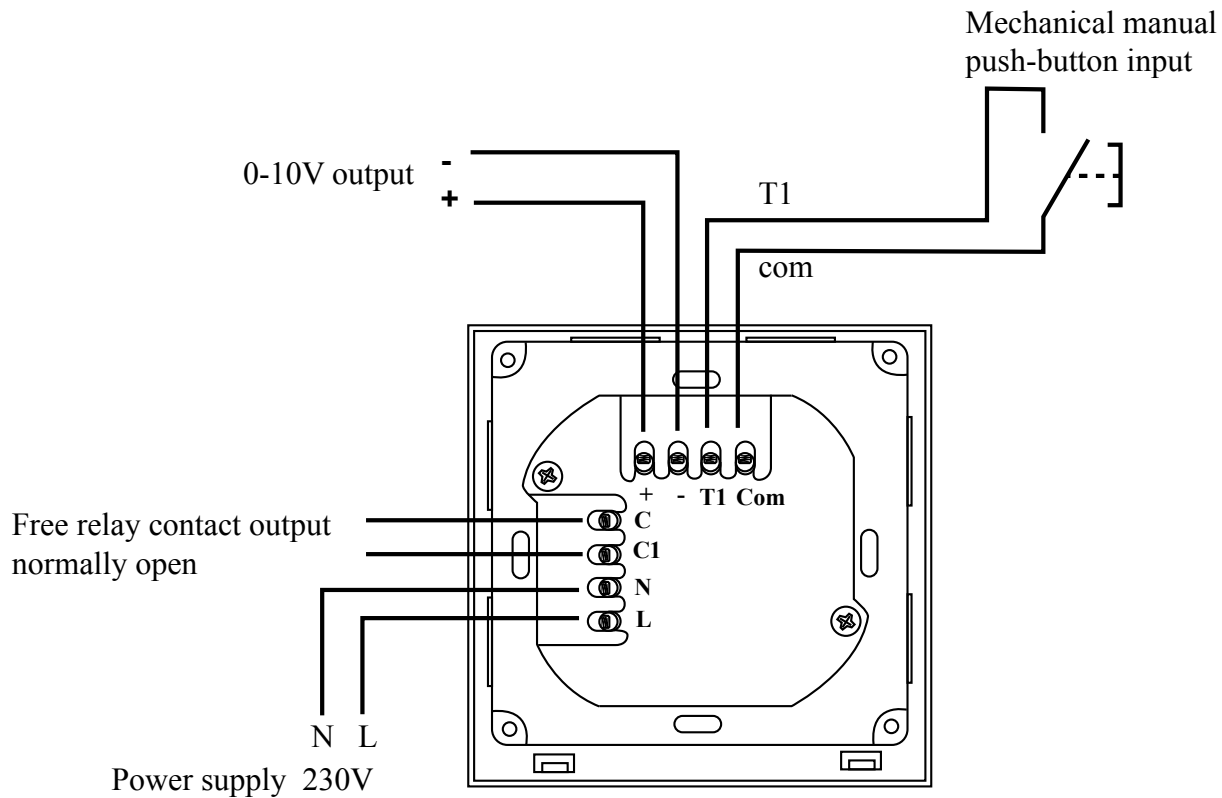

Code Number:	Series		Model number	
TVDMC868xx10	<b>TVLink RS868</b>		T510.02	19/11/12

## 2- To program the minimum level of brightness

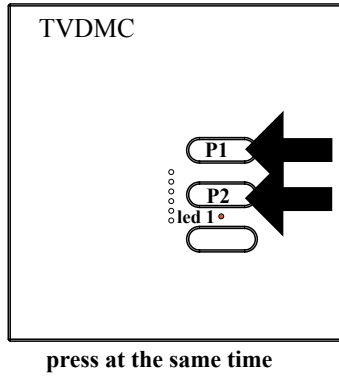

This function allows to set the minimum level of brightness that can be reached by the dimmable load.

- 1- Regulate the minimum brightness to the level desired
- 2- Press at the same time push-buttons P1 + P2 for 10 seconds. After 10 seconds led 1 will flash quickly for 10 times.
- 3- To reactivate the minimum level of brightness to the default level, press at the same time P1 + P2 for 10 seconds. After 10 seconds led 1 will flash quickly for 3 times.

## 3- Activation-deactivation memory of last value of light (light memory)

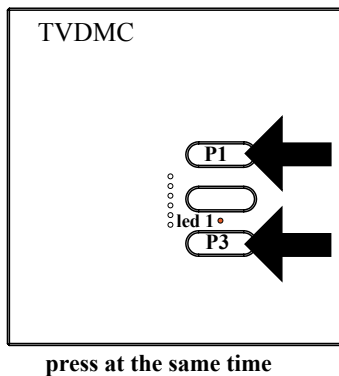

With memory function activated, by controlling the load in ON/OFF mode, at the time of turning on the light respects the values it had before turning off. The memory function is deactivated by using the 7-channel transmitter.

With memory function deactivated, the light turn on at the maximum value.

- 1- Activation-deactivation memory function: press at the same time the push buttons **P1+P3**.
  - led 1 will flash 2 times if the function will be activated;
  - led 1 will flash 1 times if the function will be deactivated.

## 4- Mechanical push button manual operation

Short impulses (<800 ms.) it turns the light on and off,  
Long impulses (>800 ms.) it increases or decreases the intensity.

### 4.1- Relay functioning

The relay contact is activated at the switching on of the load and is disabled at the switching off.

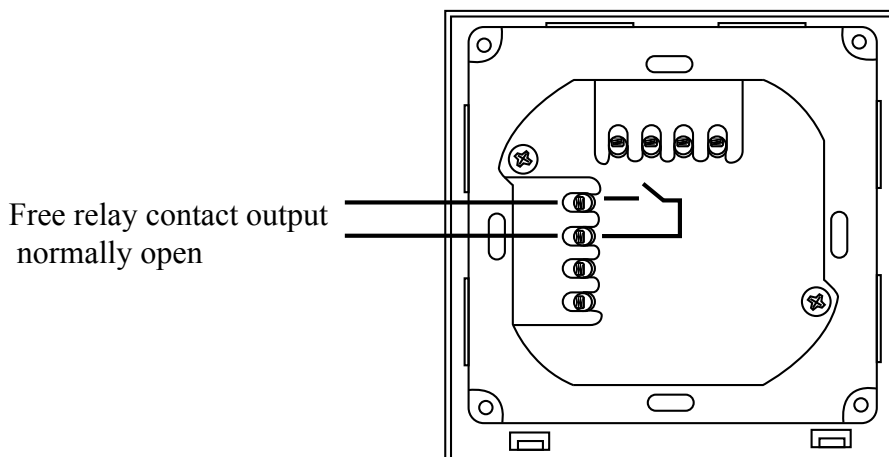

## 5- TRANSMITTER MEMORIZATION

**ATTENTION: The first transmitter can only be memorized using the receiver.**

### 5.1- To memorise 7-channel transmitters - Complete

In the first 4 push buttons it is possible to memorise 4 different light intensity values. With the push buttons CH5 and CH6 it is possible to adjust the light intensity and with push button CH7 the light will be turned off.

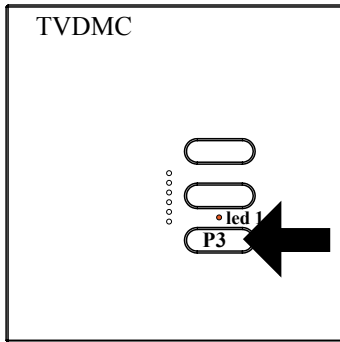

press and hold 10s

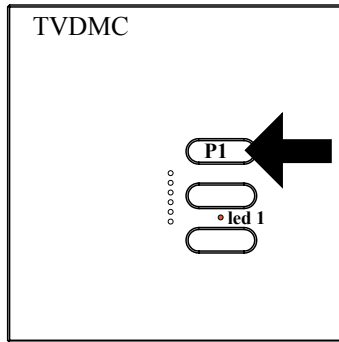

1 time and hold

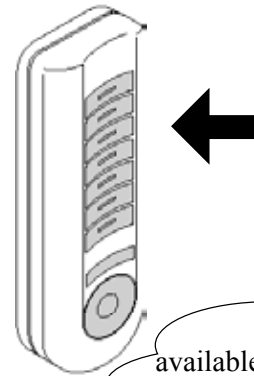

available only for 7 or 42 channels transmitter

1- Press the push button **P3 once and hold** it down for 10s; when led 1 will flash slowly, release the button.

2- Press the push button **P1 once and hold** it down, the led 1 remain lit.

3- Press one push button, of the 7-channel transmitter which has to be memorised, the memorization is indicated by the quick flash of the led 1.

All the push-buttons of the transmitter are automatically memorized.

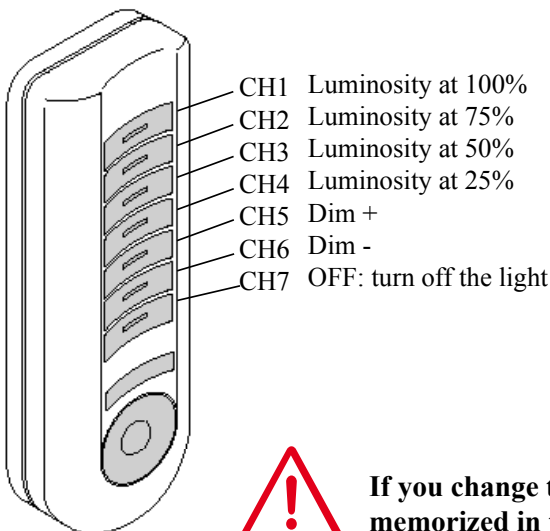

Luminosity at 100%  
Luminosity at 75%  
Luminosity at 50%  
Luminosity at 25%

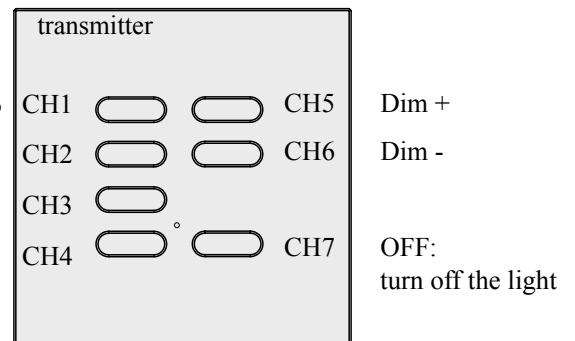

**If you change the type of load it is necessary to reset the light intensity values memorized in the first 4 push-buttons of the 7-channel transmitters.**

### 5.2- To memorise one transmitter push-button with on/off/dimmer function

with short impulses (<800 ms.) it turns the light on and off, by holding it pressed, it increases or decreases the intensity.

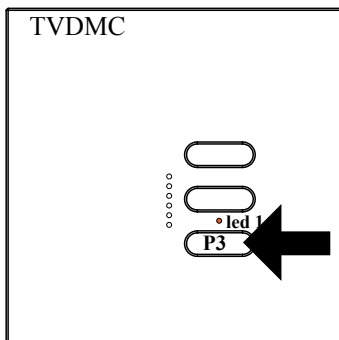

press and hold 10s

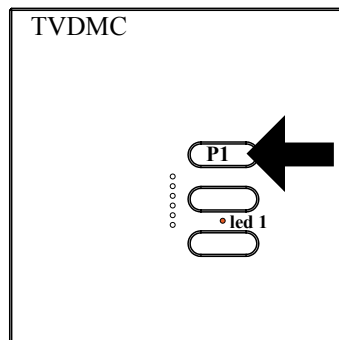

2 times and hold

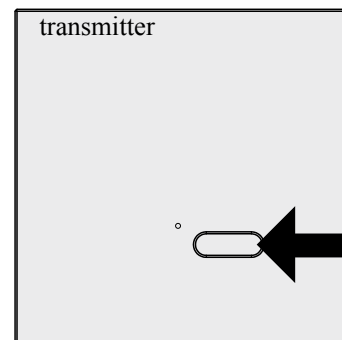

1- Press the push button **P3 once and hold** it down for 10s; when led 1 will flash slowly, release the button.

2- Press the push button **P1 twice and hold** it down, the led 1 remain lit.

3- Press the push-button which has to be memorised; the memorization is indicated by the quick flash of the led 1.

### 5.3- To memorise one transmitter push-button with ON function

The push-button memorised with ON function turns on the light.

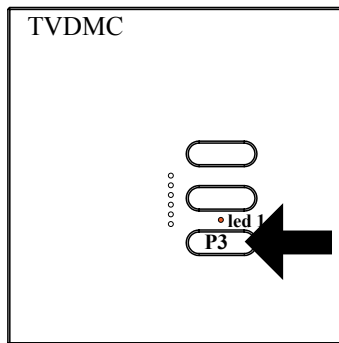

press and hold 10s

1- Press the push button **P3 once and hold** it down for 10s; when led 1 will flash slowly, release the button.

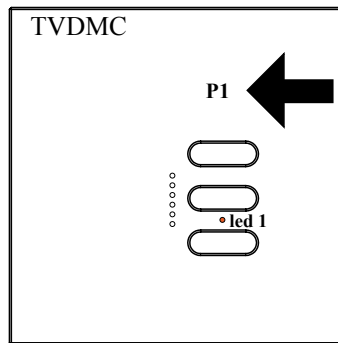

3 times and hold

2- Press the push button **P1 three times and hold** it down, the led 1 remains lit.

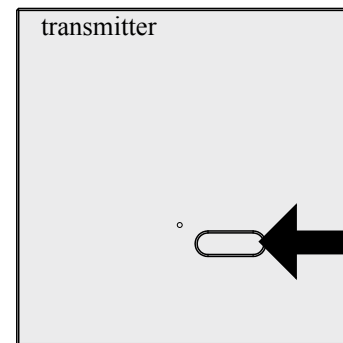

3- Press the push-button which has to be memorised; the memorization is indicated by the quick flash of the led 1.

### 5.4- To memorise one transmitter push-button with OFF function

The push-button memorised with OFF function turns off the light.

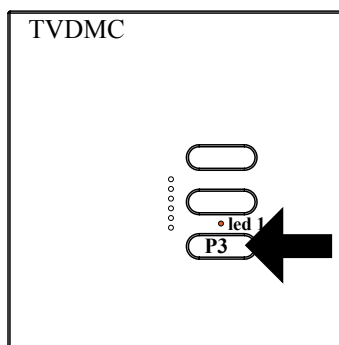

press and hold 10s

1- Press the push button **P3 once and hold** it down for 10s; when led 1 will flash slowly, release the button.

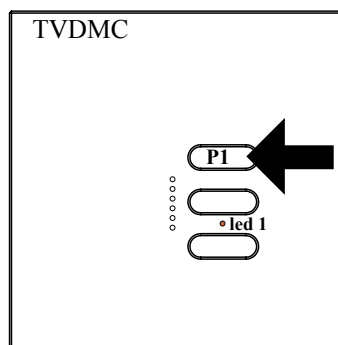

4 times and hold

2- Press the push button **P1 four times and hold** it down, the led 1 remains lit.

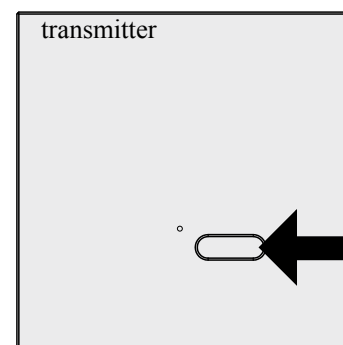

3- Press the push-button which has to be memorised; the memorization is indicated by the quick flash of the led 1.

### 5.5- To memorise 3 channel transmitters

The push buttons of the memorized transmitter will have the following functions: CH5 increases the level of brightness, CH6 decreases the level of brightness, CH7 turns ON or OFF the light.

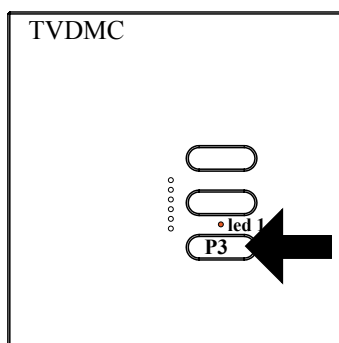

press and hold 10s

1- Press the push button **P3 once and hold** it down for 10s; when led 1 will flash slowly, release the button.

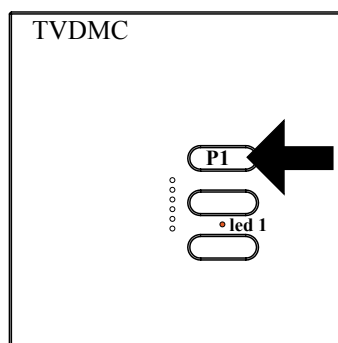

5 times and hold

2- Press the push button **P1 five times and hold** it down, the led 1 remains lit.

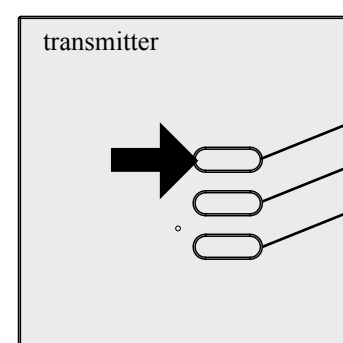

CH5: Dim +  
CH6: Dim -  
CH7: On/Off

3- Press the push-button which has to be memorised; the memorization is indicated by the quick flash of the led 1.

## 6- To change the level of light intensity of the 4 push button of the 7-channel transmitter from receiver

This procedure allows to modify the level of brightness set in the first 4 channels of a 7-channel transmitter through push buttons P1 + P2 of the receiver.

The procedure can also be used when a transmitter is memorized in more than one receiver, varying in every single receiver the value of light ( without setting the identifying number in every receiver).

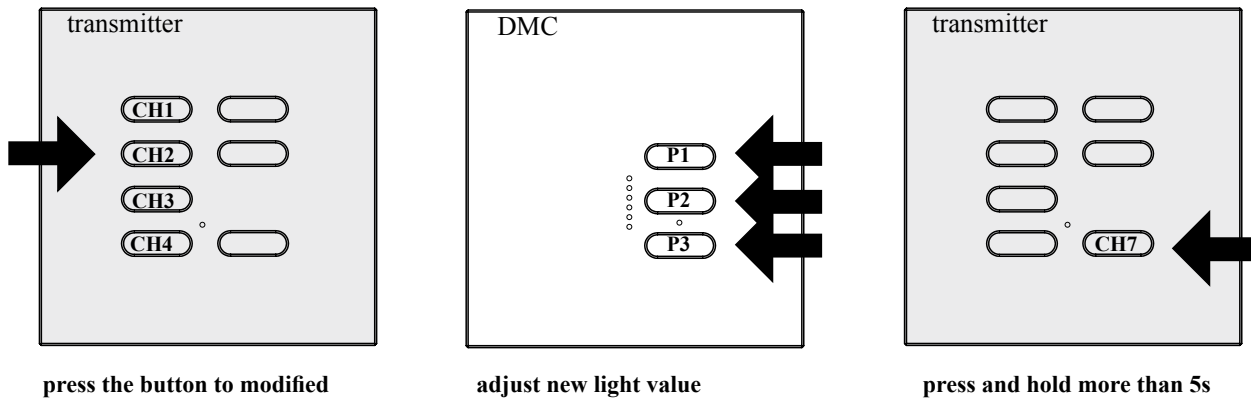

1- Press the push button to be modified

2- Regulate the new value with push buttons P1 + P2 of the receiver or press push button P3 to select OFF value (wait 3 sec for the turning off; if the light is turned off, it is necessary to turn it on before pressing push button P3 to select the OFF value).

3- Hold down the CH7 push button for 5 sec., during this time the load will turn off; - after 5 sec. the led 1 flash quickly for 5 sec. and the load will turn on at the new value.

### To assign to the push button the transparent value

The push button with transparent value does not have any function in the receiver in which it has been set.

1- press the push button you want to modify

2- regulate the new value with push buttons P1 and P2 of the receiver and press push button P3 to select the OFF value (wait 3 sec for the turning off ; if the light is turned off, it is necessary to turn it on before pressing push button P3 to select the OFF value).

3- Press and hold down push button CH7 of the transmitter for 5 sec. After 5 sec. Led 1 will flash quickly for 5 sec.

4- While led 1 flashes press P3 of the receiver. Led 1 will flash slowly for 5 sec.

## 6.1- To change the level of light intensity of the 4 push button of the 7-channel transmitter from transmitter

### Case 1:

one 7-channel transmitter memorised on one dimmer receiver

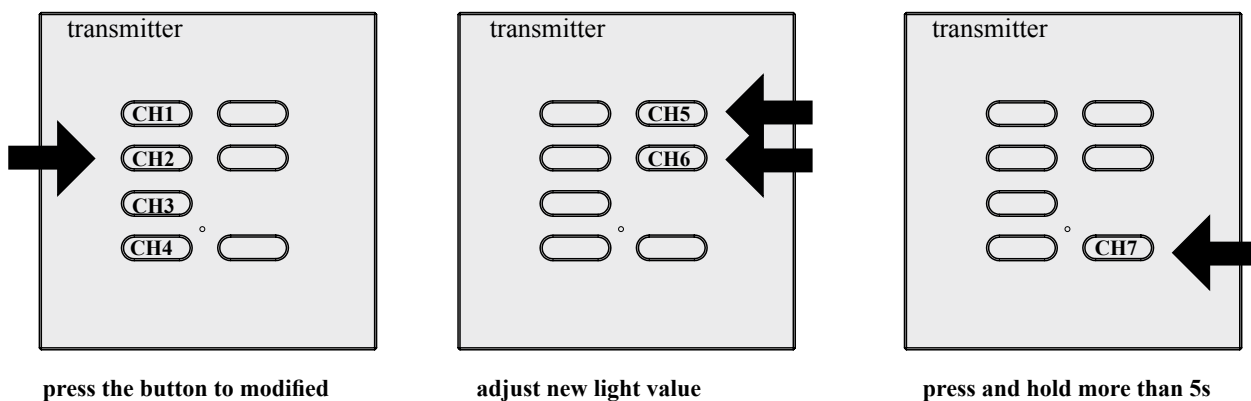

1- Press the push button to be modified

2- Adjust the new value with the two push buttons Ch5 Ch6;

2- Hold down the CH7 push button for 5 sec., during this time the load will turn off; - after 5 sec. the led 1 turns on for 5 sec. and the load will turn on at the new value.

**Case 2: (more receivers have memorised the same 7-channel transmitter)**

In the case that several receivers have the same 7-channel transmitter memorised, and each receiver must have a different value of light intensity, proceed with the programming of the identification number of the receiver. Once the identification number is programmed it is possible to select the desired receiver by means of the push buttons.

**To set an identification number of a receiver:**

The identification number associated to the dimmer is displayed by means of the leds 2 and 3: the flashings of the led 2 represents the tens and the flashings of the led 3 represents the ones.

1. Press the push button P3 once and hold it down for 10s, the led 1 will flash slowly. Release the button.
2. Press the push buttons P1 and P2 of the receiver at the same time;
3. After approximately one second led 2 and led 3 start flashing in order to indicate the identification number associated to the receiver. At the end the led 2 turns on.

For example: if the associated number is 13, the led 2 flashes once and the led 3 flashes 3 times.

4. Press the push button P1 until you reach the number to be associated to the dimmer. A maximum of 20 identification numbers are allowed. Each time the push button P1 is pressed, the led 2 turns off. After having reached the twentieth number the led 2 flashes. In case of error, reset the counting by pressing P2.

4. Memorise the set identification number and exit the procedure by pressing P3. The led 1 will flash for 3 seconds.

This operation has to be done in every receiver that has the 7 channel transmitter in common.

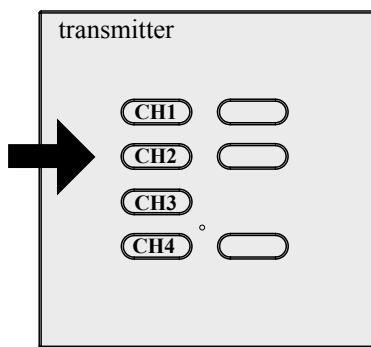

press and hold down for 5s

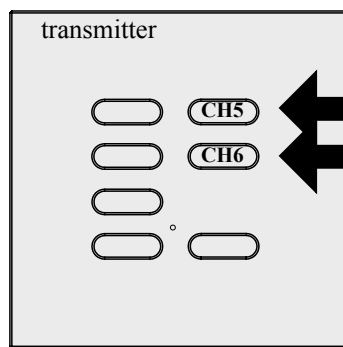

select the receiver

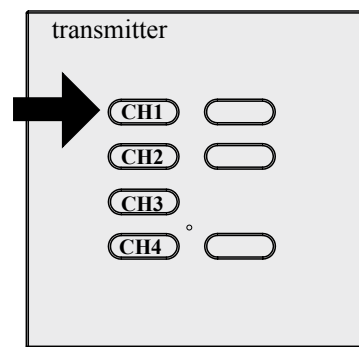

press the push button to modified

1- Press and hold one of the first 4 channels of the transmitter concerned for 5 seconds down. The light turning-off and turning-on.

2- Press the push button Ch5 or Ch6 of the transmitter in order to select a dimmer.

The selected dimmer will be the one with the turned-off light;

If the light intensity of the selected

dimmer is above 50%, the light will turn off, otherwise if the light is lower than 50% the light turns on and then turns off. In each dimmer is set an identification number which corresponds to the number of pressings of the push button Ch5 (see “set the identification number of a receiver”).

3- Press the push button of the scene which has to be modified. The dimmer turns on at the maximum value, while the others remain turned-on and blocked.

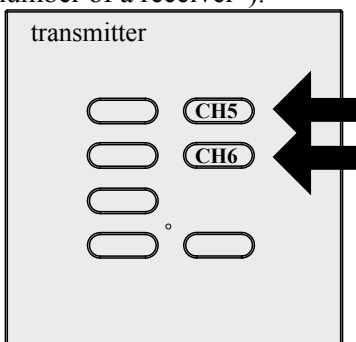

adjust new light value

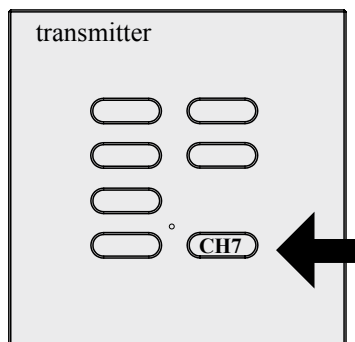

press the push button



If the procedure of scenario changing does not arrive to point 6, after 60 minutes the receiver will return to normal operation mode.

4- Set with the push buttons Ch5 and Ch6 the new light value, or pushing push button to be modify (ex. CH1) it is possible to select the ON, OFF(wait 3 sec for the turning off) or Unaffected value (not working). The passage from the OFF to the Unaffected function is signalled by one flash.

5- Press the push button Ch7 OFF to exit and memorise the new scene. The memorisation is signalled by the turning-off and turning-on of the charge at the memorised value.

With this operation all the other dimmers will be unblocked and will return to the state in point 2.

In order to modify the scene of another dimmer, repeat the points 2-6.

6. Press the push button Ch7 OFF to exit the procedure; all lights will turn off.

## 7- To copy a function of transmitter push-button to a new transmitter

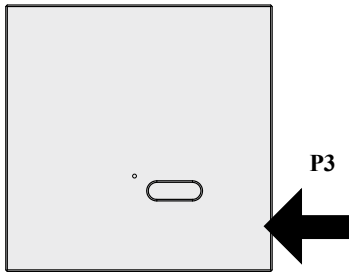

1- Press the button **P3** located inside the **already memorized transmitter**. Led 1 turns on. (the push button P3 is located inside the transmitter, see transmitter manual)

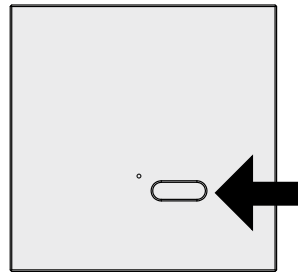

2- Within 5 seconds press a push button of the **already memorized transmitter** which has to copy the function. Led 1 turns off for 1 sec, and then it turns on for 5 seconds.

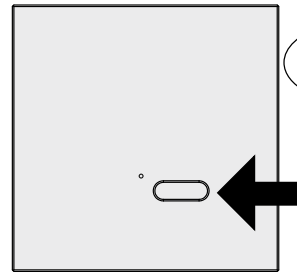

3- During the sound press the push-button of the **new transmitter** which has to be memorised; the memorization is indicated by the intermittently sound of the buzzer.

available with all type of transmitters

The new transmitter will have the same functions of the transmitter used for its memorization.

## 8- TO DELETE a transmitter

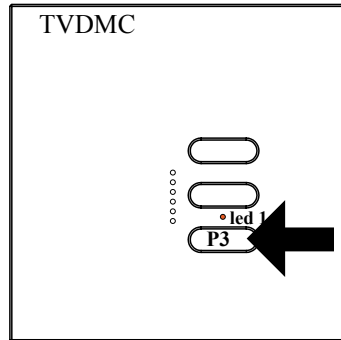

press and hold 10s

1- Press the push button **P3 once and hold** it down for 10s; when led 1 will flash slowly, release the button.

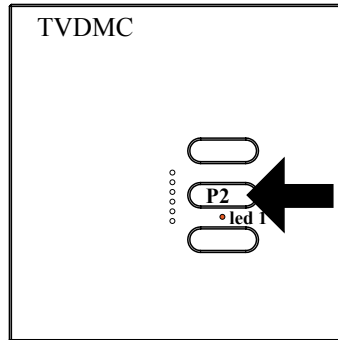

press and hold

2- Press the push button **P2 once and hold** it down, the led 1 remains lit.

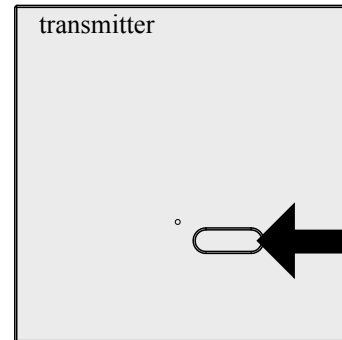

press to delete

3- Press the push-button which has to be deleted; the deletion is indicated by the quick flash of the led 1.

## 8.1- TO DELETE all transmitters

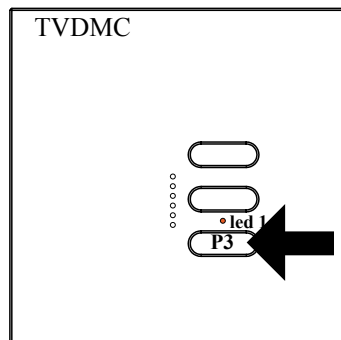

press and hold 10s

1- Press the push button **P3 once and hold** it down for 10s; when led 1 will flash slowly, release the button.

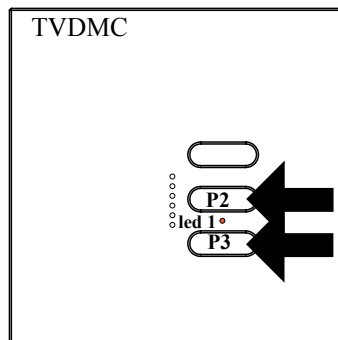

press at the same time and hold

2- Press the push buttons **P2 and P3 at the same time and hold** it down for 10s, the led 1 will flash quickly and at the end it remains lit. Release the button.

## Technical specifications

- Power supply	230V 50/60Hz +/-10%
- Output	0-10V
- Relay contact	230V 10A
- Frequency radio part	868.3 MHz
- Modulation	FSK
- Consumption on standby	0.8W
- Cable sections in input and output	max 1,5 mm <sup>2</sup>

- Possibility to memorise up to 16 standard transmitters.

In the view of a constant development of their products, the manufacturer reserves the right for changing technical data and features without prior notice.

## - Warning



### Attention

The subject appliance must be installed only by qualified technical personnel in compliance with the standards. All connections must be rated for a single-phase power supply of 230V. For the disconnection from the power line, use an all-pole switch with contact with an opening of at least 3,5mm. Only suitable materials for the connections must be used to guarantee insulation that complies with current standards on the subject of electrical safety. All the necessary safety devices are to be seen to separately.

The wires must be fixed by means of an additional fastening nearby the terminals; this fastening has to be done by qualified technical personnel during the installation phase.  
The programmer is in conformity with the RAEE and RoHS directive.

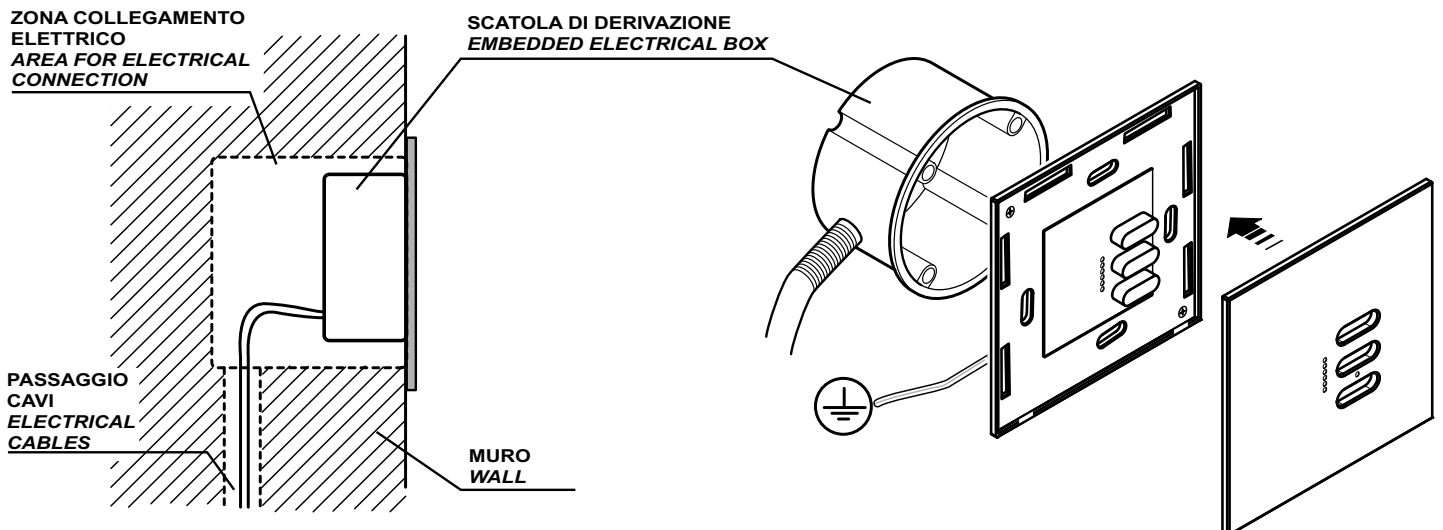

### COVER OPENING

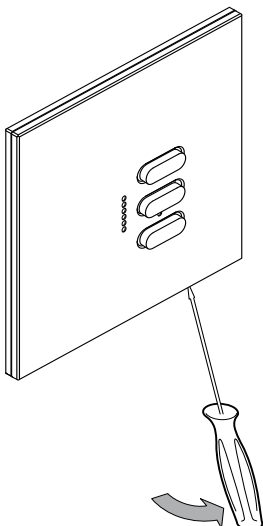

### DIMENSIONS

